

01/2023

VVA VERLAG
Cologne /Germany



EXTRUSION INTERNATIONAL

USA

Guill

WORLD LEADER IN EXTRUSION TOOLING

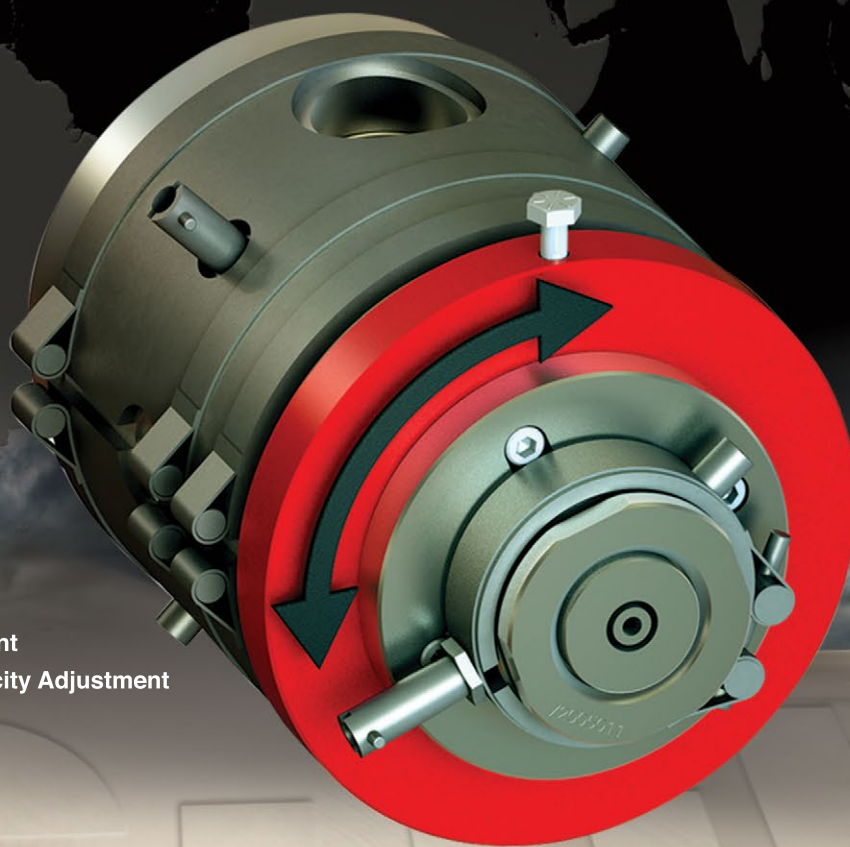

Single-Point
Concentricity Adjustment

www.guill.com

GUILL
Now Offers
Basket Dies

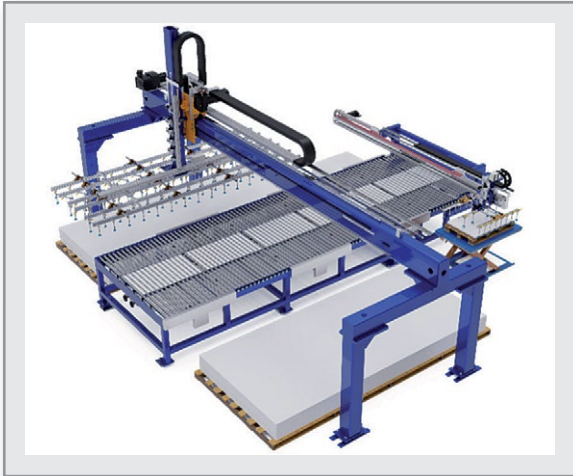
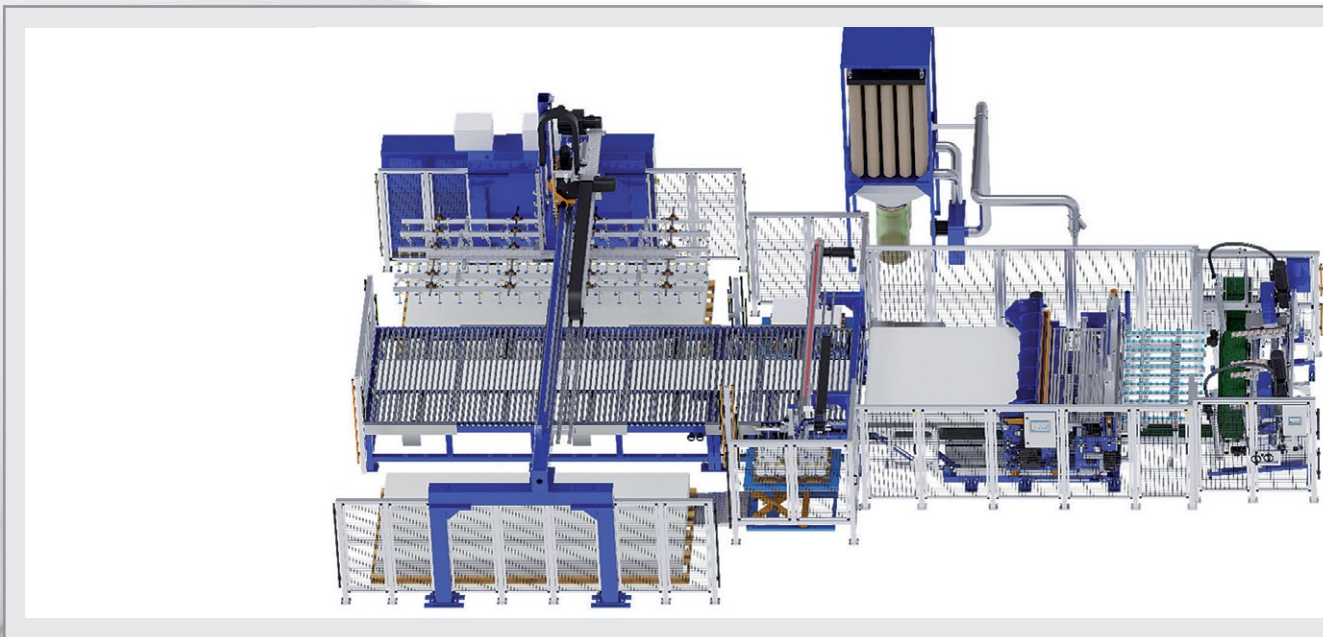

Plate Stacking Machine

for automatic depositing of your production plates on transport pallets or trolleys.

Optional available with:

- Additional stacking places
- Spreading device of sheets side by side
- Separation of consecutive panels for simultaneous stacking



Cross Cutting Combination

enables optional sawing or cutting in one machine.

Optional available with:

- Hydraulic driven scissor
- Electric driven scissor
- Cross Cut Mill instead of saw
- Cutting angle adjustment



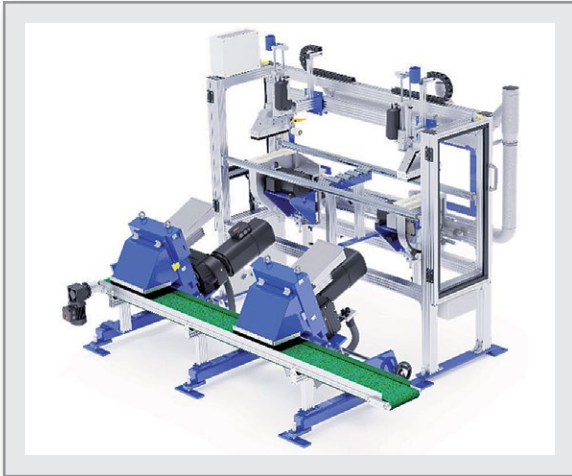

Edge Trimming Saw & Trim Strip Chopper

an unbeatable team for longitudinal cutting of your panel and direct shredding of the resulting return material.

The machines are also offered individually with many options.

As a specialist in the field of special machine construction, we always find a solution!



Pull Off Roller

provides precise regulation and compliance of roller speed and roller force.

Optional available with:

- Automatic material run control
- Selection of roller coatings
- Multiple Pull Off Roller version

Calender

for continuous dimensional accuracy and surface quality.

Key data:

- Throughput capacity depending on material 400 - 1300 kg/h
- Line speed 0,5 - 70 m/min
- Line pressure per roller: 100-1300 N/cm



STEIN Maschinenbau GmbH & Co. KG

Wartbachstrasse 9
66999 Hinterweidenthal/Germany
Tel. (+49) (0)63 96-9215-0
Fax (+49) (0)63 96-9215-25
stein@stein-maschinenbau.de
www.stein-maschinenbau.de

Firms in this issue	6	Industry News USA	24
Imprint	7	Call for Nominations for „Thermoformer of the Year“ Announced	24
Industry News	8	HPE Extruder and New DS-XEL Control to Drive Running Pipette Line at MD&M West	24
Calendar	8	Reduction of Air Emissions with New Technology	25
PLASTPOL – Hope to Rebuild Interrupted Supply Chains	8	„GLOBAL TRENDS REPORT“ Released	26
Plastics Recycling Show Europe	9	2022 Industry RECAP Provided	26
Equiplast 2023	9	2023 Recycling Committee Executive Board Announced	26
Polyamide 12 Pressure Piping Days	10	2023 Cleanup Champions	27
PlastikCity Pavilion returns for Interplas 2023	10	Inaugural ESG Report Released	27
Lighthouse Projects for Digitalization in Plastics Production Started Operation	11	CHINAPLAS 2023	28
New Company Name	12	Packaging in Industry Opportunities with RCEP	28
Strategic Partnership for Recycling PET Signed	12	Solutions for an Eco-friendly and Sustainable BO Film Production	30
Acquisition	13	Innovative Degassing and Decontamination Technologies for Demanding Recycling Applications	32
New Senior Vice President	13	With Pump & Filtration Systems, Pelletizing & Pulverizing Systems, Recycling Systems and Digital Solutions at CHINAPLAS	34
Grand Opening of the Training Center for Quality (TZQ)	14	Extrusion Tooling	
Market Study: Plastic Extrusion	14	Getting the Most from Your Extrusion Tooling	36
Acquisition	15	Extrusion Technology, Recycling	
New Record	16	Regranulation and Plastic Re-Processing	40
New Head of EU Affairs in Brussels Appointed	16	Quality Control	
International Conference „Polymer Replication on Nanoscale“	17	Next Generation of the AllRoundDia DualVision System – Now for All Colours and for Matt and Glossy Surfaces	42
wire and Tube go Türkiye	17	Periphery – From the Research	
Control System – Next Generation Introduced	18	Automated Color Control for Recycling	44
Improving the Surface Quality of Recycled Components by Means of Plasma Coating	18	Blown Film Extrusion – From the Research	
Extrusion Tooling	19	Larger Pressure Gradient – Smaller Cells	
Fully Integration of Innovative Deinking Process for Printed Plastics into the Product Portfolio	19	Optimisation of the Foam Structure with Adapted Die Design	48
New ULTRA 2200 Dryer Model	20	Measuring Technology – Case Study	
Breakthrough in Foam Extrusion	20	How to Provide Pure Raw Material for Perfect Films in Food Packaging	53
Extrusion Die for the Production of Panels Made from Recycling Textile Fibers and Plastics	21	Recycling – Case Study	
Elevate Control Functionality with DS-XEL	21	Post-consumer HDPE and PP Recycling Line for Turkish Plastics Recycler	54
100% Inspection for Printing and Slitting Machines up to 1700 mm	22		
Chemical Recycling Provides Circular Solutions for Crosslinked Polyethylene	22		
Melt Filter for Blown Film Applications	23		



28

By returning to Shenzhen CHINAPLAS shall converge different end markets and quality suppliers to foster collaborations and inspire innovations. Buyers from all over the world shall discover a well mixture of global and Chinese technologies



30

In addition to the developments for the rapidly developing circular economy, Brückner Maschinenbau is also sticking to its ambitious goals for further increasing efficiency in film production. At Chinaplas, latest solutions for the film stretching of the future will be presented



32

Gneuss provides flexible sensor solutions for pressure and temperature measurements, individually tailored to your application. Abrasion, corrosion, temperature, Gneuss offers the right solution for every challenge

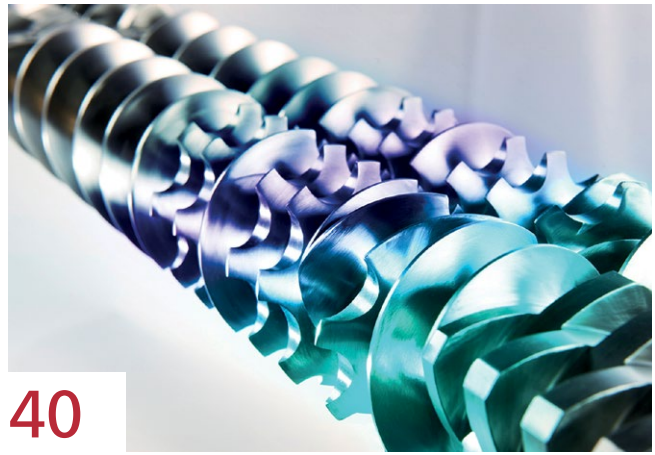

40

Bausano specializes in finding ad hoc solutions aimed at converting regenerated material into quality products, besides developing dedicated extrusion lines for the recycling of the main polyolefins (HDPE, LDPE and PP) or for the regranulation of rigid or flexible PVC

In a joint research project, SKZ - Das Kunststoffzentrum, Würzburg/Germany, and ColVisTec AG, Berlin/Germany, have developed a system for safe and material-efficient coloring during the processing of unmixed, unsorted recycled material

Featuring Starlinger's special high-vacuum degassing unit, the recoSTAR dynamic 215 C-VAC has a production capacity of two tonnes of high-quality plastic pellets per hour and processes post-consumer HDPE and PP bottle flakes



44



54

Index of Advertisers, companies and fairs referred in this issue

Adsale	28, Outside Back Cover	Nordson EDI	21
BASF	13	Nordson BKG	23
Bausano	40	Orion	25
battenfeld-cincinnati	12	Pixargus	42
Borealis	15, 22	Plastics Recycling Show Europe	9
Brückner	30	PLASTICS	26
BST	22	PLASTPOL	8
CHINAPLAS 2023	28, Outside Back Cover	Promix	20
Ceresana	14	Renasci	15
ColVisTec	44	SI Group	27
Davis-Standard	18, 21, 24	Sikora	53
Equiplast	9	SKZ	10, 11, 14, 18, 44
EREMA	12	Smart-Extrusion	47
Erge	13	SML	17
European Bioplastics	16	SPE Thermoforming Div.	24
Exelliq	12, 35	Starlinger	54
Fraunhofer Institute IPT	17	Stein Maschinenbau	Inside Front Cover+3
Gneuss	32	Targi Kielce	8
Guill Tool & Engineering	Outside Cover, 19, 36	Tube Eurasia	17
IKV Aachen	48	Vetaphone	16
Interplas	10	VM Verlag	39
Koch Maschinentechnik	15	wire Eurasia	17
KEYCYCLE	19	Zumbach	11
Lab-Conference	Inside Back Cover		
MAAG	13, 34		
Maguire	20		
Messe Düsseldorf	17		
motan	7		
Nexo Plastics	17		



Follow the news in the world of extrusion!

Subscribe to digital magazines
and Smart Extrusion weekly newsletter

- **Just** submit your **e-mail address**.
- Digital magazines and news updates **free of charge**
- No spam. Your data is safe



www.extrusion-info.com/subscription



The Extrusion International Magazine is published bimonthly by VM Verlag GmbH. P.O.Box 501812, D- 50879 Cologne, Germany

EDITORS

Bettina Jopp-Witt (Editor-in-chief)
Tel. +49 221 546 1539
redaktion@vm-verlag.com

ADVERTISING SALES

Martina Lerner
Tel.+49 6226 971515
lerner-media@t-online.de

Bella Eidlin
Tel. +49 152 29907895
b.eidlin@vm-verlag.com

Tanja Bolta
t.bolta@vm-verlag.com
+49 15205626122

ADMINISTRATION

Alla Kravets
Tel. +49 2233 949 8793
a.kravets@vm-verlag.com

PRINTING

maincontor GmbH
Dr.-Gammert-Str. 13a,
63906 Erlenbach, Germany
T.: +49 937294810811
www.maincontor.de,
info@frankhohmann.com

SALES REPRESENTATIVES

China & Asia
octavia@ringier.com.hk,
Tel. +852-9648-2561
maggieliu@ringiertrade.com,
Tel. +86-13602785446

Tokyo PR Inc. (Japan)
Tel. +81 (3) 3273-2731
extrusion@tokyopr.co.jp

Reprints, Translation etc

No part of this publication may be reproduced, stored in a retrieval system, or transmitted, in any form or by any means, electronic, mechanical, photographic, recording or otherwise, without prior permission of the publisher.



www.smart-extrusion.com

MOISTURE MINDER™

Online & Inline moisture sensor

Efficient, accurate material drying is a crucial element in the processing of engineering plastics to ensure impeccable product quality. Up to now, there has been no reliable way to continuously monitor and control that material coming out of a drying bin is dry.

The MOISTURE MINDER™ system can continuously, efficiently and accurately measure the residual moisture content of plastic granules with material throughputs from 10 to 2500 kg/h. The sensor can be mounted directly under the drying bin and accurately displays the actual moisture content of plastic granules, in % or ppm (parts per million).



ZERO LOSS

www.motan.com



3rd Annual Sustainable Bioplastics Forum" & "Sustainable Packaging Forum

1 - 2 March 2023
Brussels / Belgium
<https://inventu.eu/3rd-annual-bioplastics-innovation-forum/>

ICE Europe 2023

14 - 16 March, 2023
Munich / Germany
www.ice-x.com

KOPLAS

14 - 18 March, 2023
Goyang / Korea
www.koplas.com

Chinaplas 2023

17 - 20 April, 2023
Shenzhen / PR China
www.chinaplasonline.com

interpack 2023

04 - 10 May, 2023
Düsseldorf, Germany
www.interpack.de

PLAST 2023

05 - 08 September, 2023
Milan, Italy
www.plastonline.org

SCHWEISSEN & SCHNEIDEN

11 - 15 September, 2023
Essen, Germany
www.schweissen-schneiden.com

POWTECH

26 - 28 September, 2023
Nuremberg / Germany
www.powtech.de

Interplas

26 - 28 September, 2023
Birmingham / UK
interplasuk.com

Fakuma 2023

17 - 21 October, 2023
Friedrichshafen / Germany
www.fakuma-messe.de

PLASTPOL – Hope to Rebuild Interrupted Supply Chains



■ Companies from all over of the world prosper for new supply chains and outlet markets.

The PLASTPOL meets the processing industry's producers, distributors and contractors' expectations.

PLASTPOL 2023 promises to be a meeting point for industry representatives and business insiders from all around the world. "The expo offers the opportunity to establish cooperation, which is a rare occasion in Poland," says Kamil Perz, the PLASTPOL Project Director. "Today's global market and political situation have forced many sectors of the economy, including the processing industry, to introduce radical changes in their approach to global trade and services."

The next year in the industry will be marked by the closing of production cycles; current technology makes it possible to make machines that practically use recycled plastics. Not only is this a pivotal change but also

good news for the processing sector because it allows for a fundamental change in thinking about plastics processing.

The analyses of global institutions, which are the industry insiders have proven this trend. "The plastics industry keeps developing and introducing new technologies to the manufacturing process; this encompasses more recyclate, less virgin materials, recyclable designs and better performance designed to protect food and beverages better, a significant reduction of waste," says Matt Seaholm, president of Plastics Industry Association.

Last year PLASTPOL hosted almost 400 companies from 26 countries around the world, which used almost 10 thousand square metres as the exhibition space.

The potential of the Polish processing trade show is also recognised by global institutions, both the Embassy of Angola and Qatar Development Bank, together with Qatar Financial Centre joined the expo to present their economic potential. Not only did they exhibit at Plastpol, but they also organised a series of meetings devoted to investment opportunities as well as these countries' production industries' development prospects.

► Targi Kielce

PLASTPOL – 27th International Fair
of Plastics and Rubber Processing
www.plastpol.com
23 to 26 May 2023



Plastics Recycling Show Europe

■ The Plastics Recycling Show Europe (PRSE), the pan-European exhibition and conference dedicated to plastics recycling, returns to the RAI Amsterdam, The Netherlands on 10-11 May 2023, expanding into two halls for the first time (Halls 11 and 12).

“PRSE was such a success in 2022 with record numbers of exhibitors and visitors,” said Matt Barber, Global Events Director at Crain Communications. “We are seeing the event grow even more dramatically this year, with a great mix of both established and first-time exhibitors.”

The Plastics Recycling Show Europe is designed specifically for plastics recycling professionals. It brings together key players from the plastics and recycling sectors to showcase innovative technology, share best practice, network and do business. A broad cross-section of the industry is



represented at the event including plastics recycling machinery and equipment suppliers, plastic material suppliers and compounders, pre-processors, mechanical and chemical plastics recyclers, waste management specialists and industry associations.

A new chemical recycling feature area in Hall 11 will guide visitors through the history of and latest innovations in chemical recycling in a timeline with video displays.

Over 250 companies and organisations from across Europe have already signed up to exhibit.

The latest trends in the plastics recycling sector will be explored in depth throughout the free-to-attend, two-day conference, which provides a holistic view of the whole plastic recycling value chain, drawing together political leaders, major brands, recyclers and the plastics recycling and manufacturing industry.

Conference sessions taking place in two theatres will cover the latest political and legislative developments in plastics recycling in Europe as well as the outlook for energy supply in the EU. Materials focus sessions will explore the challenges, issues and opportunities within the sector for mechanical recycling, covering PET, PVC and Technical Plastics, polyolefin waste streams and polypropylene (PP) recycling.

The winners of all seven award categories at the Plastics Recycling Awards Europe 2023 will be announced at the event on 11 May and all finalists will be showcased in the exhibition.

► www.prseventurope.com

Equiplast 2023

■ Equiplast 2023, the International Plastics and Rubber show, sees 90% of the space available to exhibitors booked already, which suggests that this will be one of the best shows in recent years. Nowadays, 140 companies representing more than 300 brands have confirmed their participation as exhibitors at the Spanish trade fair organised by Fira de Barcelona, which will be held from 30 May to 2 June at the Gran Vía venue.

Companies will be presenting their products, innovations and solutions so that the plastics industry can meet the challenge posed by the legal obligations of the new waste and packaging Spanish regulations that have recently come into force.

In this sense, Equiplast 2023 will be a very important networking and meeting point in order to discuss the future of a sector that will have to face the new restrictions and limitations on the use of plastics, as well as the promotion of recycling included in the Spanish Law on Waste and Contaminated Soil which, among other issues, imposes a tax on single-use plastic packaging since this January.

As a great novelty, the show will feature the 'Best in Class' programme, an initiative that will recognise the best innovation developed in the field of the circular economy, digitalisation and technology transfer by a company in the plastic industry and which is being applied by a client company.



Furthermore, in its commitment to promoting sustainability, Equiplast will be exhibiting various products made from recycled material in the Rethinking Plastics exhibition.

For the first time, the event will be held at the end of May and beginning of June, in response to the demands of the main industry agents who consider this to be a more suitable month for their commercial, communication and marketing policy.

With the slogan „Connecting industry, society & sustainability“, Equiplast 2023, which will showcase the plastics sector's commitment to minimising the environmental impact of its industrial activity, will focus on the circular economy, technology transfer and digitalisation as the main themes.

www.equiplast.com/en/

Polyamide 12 Pressure Piping Days

Renowned experts will present extensive development results at the specialist conference on PA12 pressure piping on April 25 and 26 in Würzburg, Germany. The conference is primarily aimed at network operators and pipeline builders.

Unplasticized polyamide 12 according to ISO 16486 is a compound for pressure piping approved for operating pressures up to 18 bar. For gas distribution in Europe, there is a limit of 16 bar, and for this pressure range, polyamide 12 represents a corrosion-free and easy-to-laid alternative to steel that is also attracting more and more attention.

"We have looked at the developments in polyamide pressure piping from the point of view of SKZ as a testing and monitoring laboratory," explains conference chairman and deputy SKZ managing director, Dr. Jürgen Wüst. "In the meantime, we have extensive development results that are of interest to a large audience. For this reason, together with our development partners, we have decided to organize a symposium at SKZ. I am very pleased that we have been able to attract numerous renowned experts as speakers from the circle of end users, institutes



and processors, which speaks for the topicality, ambition and practical relevance of the conference content."

The topic blocks provide information on successful practical experience with pilot and commercial projects in several regions of the world as well as qualification in the field of gas distribution. In addition, aspects relating to quality and training in welding technology as well as suitability for trenchless installation and practical experience in pipeline construction will be highlighted. The program will be rounded off

Installation of pipes made of VESTAMID® NRG 2101 (PA-U 12 180) in the center of Beckum, Germany, Westnetz (Source: Evonik)

with the presentation of characteristic values for freely laid pipelines in the field of industrial applications and with information on the highly advanced status of standardization activities.

Program and registration at

➔ www.skz.de/151

Nathalie Spiegel, n.spiegel@skz.de

PlastikCity Pavilion returns for Interplas 2023

In 2023, Interplas, the definitive and longest running UK plastics exhibition will be celebrating its 75th anniversary. Amidst a host of exciting features and new developments is the return of the PlastikCity pavilion for the third edition since its debut in 2017.

The PlastikCity Pavilion was first introduced at Interplas in 2017 and following a successful second outing in 2021 the show organisers, Interplas Events Ltd, part of the Rapid News Group and PlastikCity are delighted to announce it is back for Interplas 2023, from 26 - 28 September at the NEC Birmingham.

The pavilion is designed to provide opportunities for high-quality UK & Irish suppliers that may not normally

exhibit at the show, for example, suppliers who may not have the resources to occupy a large individual stand, or who wish to dip their toe in the water for the first time to assess the benefits.

As a result of exhibiting in 2017 and 2021 several PlastikCity members have gone on to take a larger place on the show floor with the experience that their time on the PlastikCity Pavilion has given them confidence they can achieve return on investment.

Duncan Wood, CEO, Interplas stated, "We are delighted that the PlastikCity Pavilion is back for 2023. It is a big year for Interplas with our 75th birthday celebrations and this pavilion presents a great opportunity for

smaller companies to join the party. The PlastikCity Pavilion is a firm fixture on the show floor at Interplas and we look forward to seeing the breadth of suppliers on there for our visitors to connect with."

Carl Fatcher, Managing Director at PlastikCity added, "We're thrilled to once again bring the PlastikCity Pavilion to Interplas, especially for this special commemorative edition of the show. With over 100 of our partner companies exhibiting, and 20 more SMEs attending alongside us on the pavilion, the show is set to be a highlight of 2023 for the UK plastics industry."

➔ www.interplasuk.com

www.plastikmedia.co.uk

Lighthouse Projects for Digitalization in Plastics Production Started Operation

■ 16 years after the first application, the SKZ Model Factory was opened on November 09, 2022. Together with the Training Center Quality and an in-house daycare center, lighthouse projects for digitization in the manufacturing of plastic products were created in the Industrial Area East in Würzburg, Germany.

The Model Factory offers 4,700 square meters of floor space, including 1,700 square meters of pilot plants and laboratories and approximately 600 square meters of networking and conference space, as well as room for around 110 highly qualified employees. The focus of activities in the Model Factory will be the practical implementation of Industry 4.0 for the plastics industry. In the new premises, it will be possible to break down this abstract topic to concrete problems in production and application - especially for small and medium-sized enterprises. In the Model Fac-

tory, therefore, topics relevant to the future, such as digitalization in production and artificial intelligence or machine learning and individual manufacturing, as well as Testing 4.0, among others, will be comprehensively researched. A "Digitalization" research group has already been available for years as an interface to industry. In addition, a research group "Sustainability and Circular Economy" will be located in the Model Factory to meet current challenges, such as CO2 footprint and energy efficiency. Together with the industrial proximity of the SKZ, a transfer of ideas and solutions into industrial practice and a comprehensive technology transfer is efficiently possible through the conference area integrated in the model factory.

SKZ
 Dr. Johann Erath, j.erath@skz.de
www.skz.de



Zumbach
 SWISS PRIME MEASURING SINCE 1957

Zumbach RAYEX S 90

- min 2 Min. object diameter (mm)
- max 100 Max. object diameter (mm)
- up to 20 Scan rate (scans/s)

RAYEX® S Static X-Ray Measuring System

Benefits:

- ✓ All in one! Complete system for precision measurement of wallthickness, ovality, eccentricity and diameter.
- ✓ Fast measurement, immediate response to product changes.
- ✓ Operator friendly due to smart measurement algorithms.
- ✓ State of the art connectivity with integrated Profinet IO, Ethernet TCP/IP, Ethernet IP, or OPC UA communication protocols.
- ✓ Minimum maintenance requirement.



Zumbach Electronic AG
 Hauptstrasse 93 | 2552 Orpund | Schweiz
 Telefon: +41 (0)32 356 04 00 | sales@zumbach.ch
www.zumbach.com

New Company Name

■ As of 22 of December 2022, the company Greiner Extrusion, including its international locations, has changed its name to Exelliq. The subsidiary GPN GmbH remains with its name and logo.

Exelliq enters the future strengthened with a new name and modern branding. However, not everything will be new, rather the company is convinced that the future ownership structure of Exelliq will enable its customers to further expand their leading market position, the quality of its product portfolio and its innovative strength. Only the company names will change worldwide – the respective



company register numbers and VAT numbers will remain unchanged. In addition, the business relationships will remain unchanged – and in the future you will be able to profit even more from possible synergies from the combination of the joint know-how and the bundled capabilities of Exelliq and its now sister company battenfeld-cincinnati.

For Exelliq, the logo with the new name symbolizes the momentum towards a digitally networked and fully automated future of extrusion with excellence and high quality. Already since 1977, the company, as a global group of experts, has been striving to offer customized and high-quality complete solutions. Customers are provided with the best possible support throughout the entire extrusion performance process, with continuous vision and new perspectives. An essential part of the activities remains the permanent further development of innovative, automated and digital solutions – an aspect that the new corporate identity additionally underlines.

➔ **Exelliq Austria GmbH**
www.greinerextrusion.com

battenfeld-cincinnati
www.battenfeld-cincinnati.com

Strategic Partnership for Recycling PET Signed

■ INTCO is a Chinese recycling company active worldwide that has become one of the largest recyclers and end users of waste expanded polystyrene (EPS). Every year, INTCO recycles around 100,000 tonnes of EPS waste that it acquires around the globe and processes it into new high-quality consumer goods, such as picture frames, that are then sold in well-known furniture stores. Frank Liu, founder and chairman of INTCO Medical Technology Co., Ltd. and Shandong INTCO Recycling Resources Co., Ltd. also applies this circular economy concept when recycling PET waste. Having been active in this segment for five years, INTCO is planning major investment in the expansion of PET recycling solutions over the next few years.

Recycling capacity is to increase to up to one million tons per year

"We also want to become the leading supplier in this segment and increase our PET recycling capacity from the current level of around 150,000 tonnes a year to one million tonnes in the coming years," explains Frank Liu: "To do this, we need an experienced and reliable technology partner, which we have with EREMA at our side."

INTCO has trusted in the technologies and service provided by the Austrian recycling machine manufacturer for more than ten years. Just a few months ago, a VACUNITE® bottle-to-bottle recycling system started production in Malaysia. "We are pleased that INTCO have decided to further inten-



Michael Heitzinger (EREMA GmbH), Manfred Hackl (EREMA Group) and Frank Liu (INTCO) signed the strategic partnership at K 2022 (Photo credit: EREMA)

sify their work together with us, focusing on PET recycling," says Manfred Hackl, CEO EREMA Group GmbH. Regarding the benefits of this partnership, he comments, "INTCO is a partner who also have the end product in mind from the very beginning with their recycling solutions. Promoting a circular economy for plastics is our shared objective, which requires the highest possible quality of recycled pellets. That's exactly where the strength of our team comes in, as well as our patented technologies, which we are constantly developing together with our customers and partners."

➔ **EREMA Engineering Recycling Maschinen und Anlagen GmbH**
www.erima.com

Acquisition

■ MAAG Pump Systems announced that it has acquired Witte Pumps & Technology. Founded in 1984 and based in Tornesch, Germany, Witte Pumps & Technology GmbH develops and manufactures gear pumps and provides aftermarket parts and services for the chemical, plastic and polymer processing, food and beverage, and pharmaceutical industries. Witte’s deep experience, know-how and broad-ranging advanced technical knowledge allow it to deliver world-class customized solutions to its blue-chip customers across the globe.

With the acquisition of Witte, MAAG will establish a new integrated Gear Pumps business unit, which will be led by the Managing Director and former owner of Witte Pumps & Technology GmbH, Dr. Sven Wieczorek. Creating the Gear Pumps business unit will enable MAAG to serve its customers even more effectively by leveraging an expanded and integrated footprint, delivering an enhanced product portfolio and offering complete solutions to a wider range of customer needs. MAAG has production sites in Switzerland, Germany, Italy, the USA and China, as well as service centers and sales offices in France, Taiwan, Malaysia, India, Thailand and Brazil. Witte Pumps & Technology GmbH manufactures in Germany and has sales offices and service centers in the USA and China.

► MAAG Group
www.MAAG.com



Ueli Thuerig, President MAAG Group: "The acquisition of Witte represents a major step in making MAAG the go-to partner for our customers’ most critical and demanding gear pump needs. MAAG’s advanced and vertically integrated manufacturing capabilities will increase the availability and supply security of gear pumps to Witte’s customers. Combining Witte and MAAG’s gear pump businesses into a new integrated business unit will amplify the attractiveness of our technological solutions and product offerings to our customers, and our worldwide footprint will allow us to better serve our global customer base."

New Senior Vice President

■ BASF has appointed Dr. Achim Sties to lead the global plastic additives business unit effective January 1, 2023. The headquarters of this business will be in Singapore.

Prior to his current role, Achim Sties was already heading the plastic additives business in Europe. He began his career with BASF in 2005 in Ludwigshafen, Germany, and held various positions in different functions in Europe and South America. He holds a PhD in economics from the University of Heidelberg, Germany.

"We proactively collaborate with our customers and the relevant stakeholders to create new value for plastics. Our new brand VALERAS™, under which we bundle all products and services of our plastic additives portfolio that deliver significant sustainability benefits, continuously evolves to support our customers on their plastics journey. We are combining our resources and expertise for plastic additives worldwide into a global business unit to focus on the increasing challenges and truly drive the business to the next level. I am excited to deliver on this promise with my team," said Achim Sties.

► BASF Plastic Additives
www.plasticadditives.basf.com



ERGE Elektrowärmetechnik - Franz Messer GmbH
 91220 Schnaittach - Hersbrucker Straße 29-31
 Tel. +49/9153/921-0 Fax +49/9153/921-117
 www.erge-elektrowaermetechnik.de
 mail: verkauf@erge-elektrowaermetechnik.de

HEIZEN
HEATING

TROCKNEN
DRYING

REGELN
CONTROLLING

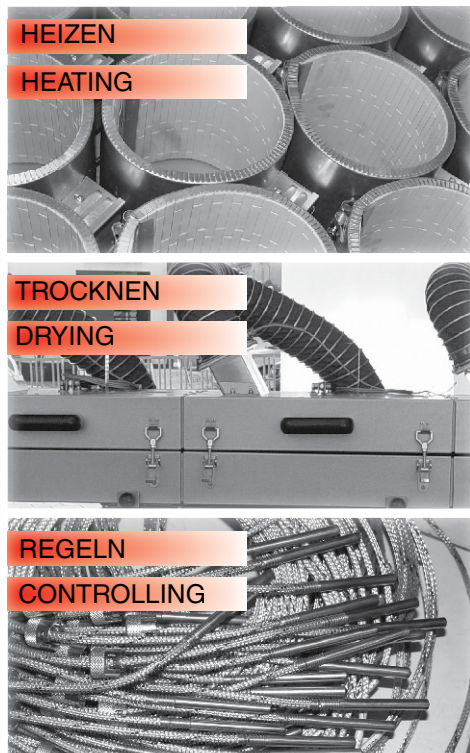

ELEKTROWÄRME TECHNIK FRANZ MESSER GMBH

Grand Opening of the Training Center for Quality (TZQ)

■ The Training Center for Quality (TZQ) will open its doors on March 2, 2023. The German Plastics Center (SKZ) is thus significantly expanding its range of training courses in the field of quality management.

Since its founding in 1961, the mission of SKZ has been to advance the continuing education of career changers, skilled workers and engineers in the plastics industry. With more than 10,000 participants annually at 6 further education locations in Germany and many more at in-house training courses, SKZ is known worldwide in the plastics industry for its courses and training. In this context, a genuine practical component in the courses is a key quality feature for effective continuing education. To take this step further, SKZ celebrates the commissioning of the state-of-the-art Training Center Quality (TZQ) in Würzburg's Industrial Area East and opens its doors to all interested parties, partners and supporters on 2 March.

Large rooms, extensive equipment in the training labs, and innovative learning and teaching methods are intend-



ed to help continuously improve the already high quality of SKZ's advanced training courses. In the advanced training courses, the focus is above all on a strong connection to practice. A highlight of the new building will therefore be the intelligent networking of training rooms and technical centers. On March 2, guided tours of the TZQ will be offered in the morning. The afternoon will be dedicated to informative lectures and presentations.

"The opening is the next big milestone for us. Now participants will

Visualization of the TZQ (Image: Architekten BDA, Würzburg)

soon be able to enjoy the new training center. For this, 90 courses per year are planned, each with 5 to 15 places. I'm really looking forward to being able to present to all interested parties what the TZQ has to offer," says a delighted Christoph Kreutz, head of the TZQ.

SKZ

Matthias Ruff, m.ruff@skz.de

Market Study: Plastic Extrusion

■ Pipes, sheets, profiles and hoses in almost any length: next to injection molding, extrusion is the most important process in the plastics industry. In fact, more thermoplastics and elastomers are forced through molding dies at high pressure than are cast: Extruding and extrusion blow molding are used to process about 25 million tonnes of plastics per year in Europe. Ceresana has specifically examined the European market for extrusion plastics.

The study in brief:

Chapter 1 provides a description of the European plastics extrusion market - including forecasts up to 2031. Demand and revenues are outlined for countries in Western and Eastern Europe.

It also breaks down demand for each type of plastic: polyvinyl chlo-

ride (PVC); polyethylene - LDPE; polyethylene - LLDPE; polyethylene - HDPE; polypropylene (PP); polystyrene (PS); polyethylene terephthalate (PET); others.

Chapter 2 looks at country-specific market data for 22 countries in Europe, i.e. demand and revenues of extrusion plastics in each case.

Demand is examined in detail for individual product types and various application areas: Packaging; Construction; Transportation; Electrical & Electronics (E&E); Industrial Products; others.

Chapter 3 provides a useful directory of the 74 most important European companies in the plastics extrusion sector. It is clearly organized by contact details, revenues, profit, product range, production facilities and brief profile.

Market Study: Plastic Extrusion



Ceresana
Market Research Since 2002

Ceresana

www.ceresana.com/en/market-studies/industry/plastic-extrusion-europe/

Acquisition

■ Borealis has acquired a majority stake in Renasci, a Belgium-based provider of innovative recycling solutions and the creator of the novel Smart Chain Processing (SCP) concept.

Borealis announced the acquisition of a 10% stake in Renasci in July 2021; today it announces an increase of its investment to acquire a majority stake of 50.01%, signalling on-going confidence in the potential of Renasci's patented SCP concept to drive the circular transformation. The investment is an important component of Borealis' strategy to reach its ambitious circular goals, which target a six-fold increase in the volume of circular products and solutions to 600 kilotonnes by 2025, rising to 1.8 million tonnes by 2030. The acquisition will support Borealis to reach these goals by providing increasing long-term access to chemically recycled feedstock from Renasci's Ostend facility and through enabling access to key circular technologies.

SCP is unique because it enables the processing of multiple waste streams using different recycling technologies under one roof, resulting in exceptionally high valorisation of waste. Through leveraging its market access, know-how, and innovative technological capabilities, Borealis will accelerate the implementation of the SCP concept and will also explore opportunities for replicating the model in strategic locations.

The controlling stake in Renasci will support Borealis to further strengthen its Borcycle™ C range of product offerings by providing future supply security of chemically recycled feedstock. Borcycle C is a portfolio of transformational chemical recycling solutions with ISCC (International Sustainability & Carbon Certification) PLUS-certified content based on the mass balance approach, giving polyolefin-based, post-consumer waste another life. Chemically identical to products derived from fossil feedstock, Borcycle C solutions are suitable for all applications, including those that are subject to stringent quality and safety regulations such as healthcare and food packaging, which cannot always be met using mechanically recycled materials.

➔ Borealis Group
www.borealisgroup.com

Renasci plant in Oostende,
 Belgium (Photo: © Renasci)

Renasci N.V.
www.renasci.be/en



Energy-efficient granulate drying plant

Competence with KOCH

Top-class peripheral technology!



FASTI-KOCH granulate dryer

Top-mounted dryer for small to medium throughputs:
 Intelligent drying with ERD compressed air technology

GRAVIKO-Series

Gravimetric dosing and weighing, checking, correcting and evaluating in one operation



KKT-Series

Efficient and energy-saving auxiliary dryers for plastic granulate

KEM-Series

Dosing and colouring unit with chamber volume dosing with touch control unit



Werner Koch
 Maschinentechnik GmbH
 Industriestr. 3
 D-75228 Ispringen

Tel. +49 7231 8009-0
info@koch-technik.de



www.koch-technik.com

New Record

■ Although travel became easier than in 2021, this year has brought other challenges for manufacturers in all sectors of the industry. So Vetaphone is delighted to report a record sales performance that saw its target for the year surpassed shortly into the final quarter, making a fitting tribute to its founding father Verner Eisby, whose centenary occurred earlier in the year.

Speaking for the company, VP Sales & Marketing Kevin McKell explained: "Despite ongoing trading conditions that have been testing, to say the least, we are proud of the way we have coped with delays and com-

ponent shortages and managed to maintain our customary high level of customer support. The inherent reliability of our technology is a result of our commitment to ongoing R&D and it's at times like this that it stands us and our customers in good stead."

Supporting its bold decision in 2021 to forego trade shows as an exhibitor, the level of enquiries and sales this year has been at a record high across the company's extensive portfolio of corona and plasma treaters. Vetaphone's Showroom and unique Test Lab facilities at the company's HQ in Denmark have allowed customers to

have full demonstrations of the Vetaphone equipment, something that has been well received in 2022.

Marketing Director Jeannette Woodman explained: "We have taken the demonstration of our products a step further by having powered-up equipment in the showroom. This has not been possible until now and it offers new and exciting ways to showcase our technology and, in many ways, – be it as one-to-one online customer meetings, Masterclasses, or in person demonstrations". The Test Lab adds a new dimension by offering customers the chance to test the performance of substrates prior to a commitment to commercial production.

By adopting a more focused approach to the promotion of its technology and reaching a larger customer base, Vetaphone says it has made better use of resources. Jeannette Woodman added: "We have an extensive product portfolio that spans a wide range of applications, and our customers are located all over the world. By analysing the different requirements of each industry sector and geographical region we can be far more specific in our marketing – so it now has a greater relevance to the intended audience."

Despite component delays and shortages Vetaphone manufactured and sold a record number of corona and plasma treatment systems in 2022



➡ Vetaphone A/S
www.vetaphone.com

New Head of EU Affairs in Brussels Appointed

■ European Bioplastics (EUBP), the association representing the bioplastics industry in Europe, announced the appointment of Roberto Ferrigno as Head of EU Affairs. He assumed his position on 1 January 2023 and will be based in Brussels. He is also head EUBP's new Brussels office opened on 1 February 2023.

European Bioplastics and its members are happy to welcome Roberto Ferrigno as part of the EUBP team. Bioplastics have become an increasingly important topic in the debate of the European Union's efforts to achieve its ambitious climate goals.

"Roberto perfectly fits into the EUBP team, into this group of proven experts when it comes to biobased and compostable plastics," says Stefan Barot, Chairman of EUBP. "He's already been working within the bioplastics industry for a long time and brings with him many years of experience in Brussels. I have no doubt that he is the right person to represent our industry's interests in the capital of Europe at this crucial time," he adds.

Since many years, Ferrigno has been working with a great number of different stakeholders from the bioeconomy. He is now looking forward to taking up new challenges by

representing the bioplastics industry in Europe. "It's the right time to join EUBP. The Green Deal and its related policy initiatives provide a unique opportunity to achieve a comprehensive acknowledgement of bioplastics and their role in establishing a resource-efficient, climate-friendly biobased economy in Europe," says Ferrigno. He will make sure that EUBP continues to play an active part in the discussions impacting the bioplastics sector by engaging with EU policy makers and the broader range of stakeholders.

➡ European Bioplastics (EUBP)
www.european-bioplastics.org

International Conference "Polymer Replication on Nanoscale"

Processes for the cost-effective production of micro- and nanostructured surfaces from polymer material are in great demand for the industrial mass production of functional films and molded components. Existing injection molding and roll-to-roll processes often cannot yet achieve the required throughput and sufficiently high reproducibility for many promising product ideas. The ninth international conference "Polymer Replication on Nanoscale" (PRN), which will take place in Aachen, Germany, on June 1 and 2, 2023, will therefore focus on processes for more efficient production of functional nanostructured surfaces and present possible solutions.

Researchers and companies working on these topics can submit a one-page abstract until March 31, 2023, to be selected as a presenter at the conference. Online registration for the conference is also open now.

The conference series has been held since 2014 at alternating research locations in Denmark, Switzerland and Germany and has established itself as an important international forum for leading experts in the field of replication of micro- and nanostructured polymer materials. The aim of the conferences is to network and exchange information on developments, research results and future visions for polymer micro- and nanomanufacturing and its applications. The two-day event will be framed by a social program of guided tours and an evening networking event.

The conference will offer participants presentations of selected speakers around the large-scale replication of micro- and nanostructures in polymer materials.

For an opportunity to participate in the conference as a speaker, a one-page abstract of the proposed presentation should be emailed as a PDF

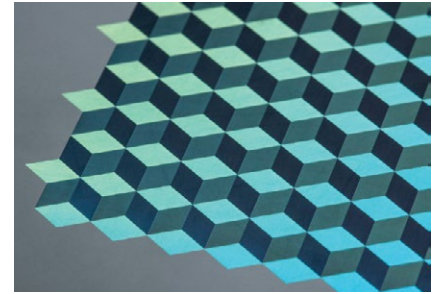

Laser-induced LIPSS structures with the design of retroreflectors (© Fraunhofer IPT)

to: prn@ipt.fraunhofer.de; Subject: PRN2023 Abstract [NAME] for [LECTURE/POSTER] Presentation.

The template provided at www.prn-conference.com/abstract should be used to prepare abstracts.

Fraunhofer Institute for Production Technology IPT
www.ipt.fraunhofer.de/prn23-en
prn@ipt.fraunhofer.de

wire and Tube go Türkiye

From 24 to 27 May 2023 the new trade fairs wire Eurasia and Tube Eurasia will be held for the first time in Istanbul.

With this move Messe Düsseldorf expands its wire and Tube portfolio in the direction of Turkey and Asia.

wire and Tube Eurasia will initially be run as an investment business venture during the two Turkish trade fairs Wire Tech Istanbul and Tube + Steel Istanbul. These two events are held by Tüyap Fair Istanbul, the leading Turkish trade fair organiser and venue operator, at the Tüyap Fair Convention and Congress Center. From 2025 wire and Tube Eurasia will then be organised as independent trade fairs at two-year intervals.

Messe Düsseldorf GmbH
www.wire-eurasia.com
www.tube-eurasia.com

▶ **each detail matters for unrivalled performance**

Only a company who has a constant focus on the productivity of its customers thinks ahead and creates extrusion solutions that leave the rest standing. SML specialises in the development of extrusion lines for film, sheet, coating and lamination as well as multifilament spinning lines.

Extrusion lines. Engineered to perform.



SML
EXTRUSION LINES – ENGINEERED TO PERFORM ▶

Be sure not to miss SML at the **CHINAPLAS 2023**
 Stand No. 10A51

www.sml.at



Control System – Next Generation Introduced

■ The next generation of Davis-Standard's supervisory control technology is here – introducing the EPIC IV®. This control system builds upon the comprehensive, user-friendly approach of the EPIC III® while enhancing the operator's experience and adding connectivity to Davis-Standard's cloud-based solution, DS Activ-Check™. Advantages include improved graphics and symbols, additional diagnostic and efficiency tools, and screens focused on active functions and alerts.

"The EPIC IV® uses a high-performance HMI approach to strengthen the operator's experience," said John Clemens, Davis-Standard's Director of Extrusion Controls. "The new color scheme focuses operator attention on active functions and alerts while also assisting operators with color vision deficiency by using shapes to indicate machine status. Overall, this will be a better supervisory control package for global installations moving forward."

The updates seen in EPIC IV® reflect customer feedback and a commitment to digital transformation via DS Activ-Check™. The "smart" technology of DS Activ-Check™ enables real-time predictive maintenance by providing early notifications of potential machine failures. As a result, operators are alerted to issues before they happen, reducing unplanned downtime and collecting valuable data in sync with EPIC IV® control features. Users receive notifications via e-mail or text, and continuous monitoring of production machine status is available on smart devices and remote PCs. Key parameters monitored include extruder reducer, lubrication system, motor characteristics, drive power unit, barrel heating and cooling functions.

The EPIC IV® will replace the EPIC III® as the standard offering for supervisory control on all new Davis-Standard ex-

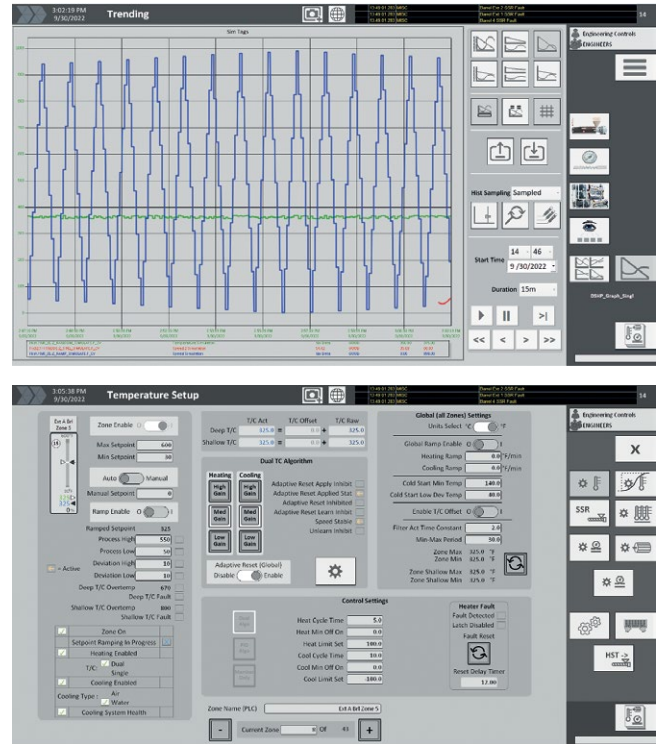

EPIC IV® enhanced operator screens

truders. It will also be available as an upgrade for existing EPIC supervisory control systems.

► Davis-Standard, LLC
www.davis-standard.com

Improving the Surface Quality of Recycled Components by Means of Plasma Coating

■ In a joint research project, the German Plastics Center SKZ and Fraunhofer IFAM are investigating the possibilities for improving the surface properties of recycled plastics with regard to adhesive applications. Activation and coating processes with

Surface activation with static atmospheric pressure plasma (Photo: SKZ)



atmospheric pressure plasma serve as the means of choice for this.

Plastic components made of recycled material or with a defined recycled content often exhibit considerable fluctuations in their material composition due to the material and process, which leads to inhomogeneous and fluctuating surface properties. Reasons for this are a varying molecular weight distribution of the recycled plastic, the loss of stabilisers and other functional additives as well as the possible contamination with foreign material. Consequently, process steps downstream of reprocessing and forming – for example, bonding, painting, printing and coating – are prevented or made more difficult because they are based on defined and consis-

tently adhesion-friendly surface qualities.

The aim of this project is to favour the use of recycled materials for surface-specific processing steps by adapting the surface properties. This is to be achieved by atmospheric pressure plasma pretreatment processes and deposition of an adhesion-promoting layer by means of plasma polymerisation (PECVD - Plasma Enhanced Chemical Vapour Deposition). In this process, the surface variance of the recyclate surfaces is leveled out so that an increase in adhesion for subsequent bonding is achieved. In addition, a migration barrier for additives from the recyclates is possible.

► German Plastics Center SKZ
Alina Heihoff, Scientist, a.heihoff@skz.de

Extrusion Tooling

■ Guill has introduced the latest generation of its Series 800, the 2-to-6 layer extrusion tooling designed to produce the highest quality, highest material-efficient 1/8" to 6" OD tubing for automotive, medical, appliance and industrial applications at MD&M in Los Angeles in February this year. The redesigned Series 800 produces flawlessly smooth extrusion and layer definition of Fluoropolymer and other materials for all multi-layer, multi-lumen medical tubing, as well as fuel line constructions, multi-layer PEX pipe and drip irrigation applications, among others. The Guill design further allows thin layer combinations of polymers and adhesives to .02mm or less.

Guill offers its extensive line of crossheads and inline tubing dies in fixed and adjustable center, for single or co-extrusion applications. The tooling is designed to process all compounds and features the company's patented, precision Feather Touch Concentricity adjustment, the Seal Right System, which combines with the Feather Touch system to eliminate polymer

leaking. Guill also offers its unique spiral flow distribution system.

All Guill tooling is produced with rigorous computer simulation of the flow channels using Computational Fluid Dynamics (CFD) programs, resulting in optimum uniform flow with no weld lines.

► Guill Tool & Engineering
www.guill.com

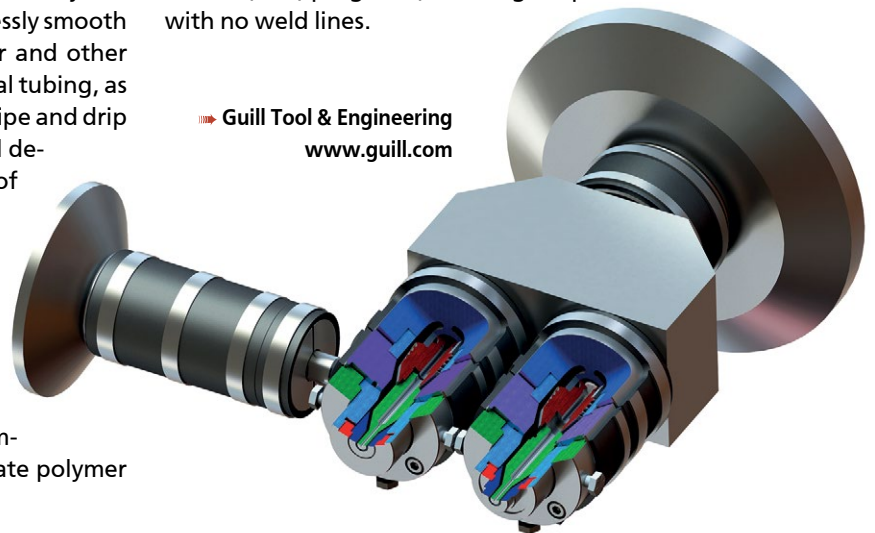

Fully Integration of Innovative Deinking Process for Printed Plastics into the Product Portfolio

■ KEYCYCLE, a subsidiary of the EREMA Group, has worked together intensively for two years with the Spanish company Cadel Deinking to further develop the innovative process of removing printing inks from the surface of plastic. This has proved successful, because there are now several deinking lines in operation at customers' sites, where they are proving their efficiency in processing printed inhouse and post industrial film waste. Having acquired the Cadel Deinking brand, KEYCYCLE will now continue to develop the technology and market the deinking process under the KEYCYCLE Deinking brand.

"We have already been exclusively responsible for the worldwide distribution of this patented technology since January 2021, including the operation of the pilot plant together with Cadel in Sant Vicente del Raspeig (Alicante). By acquiring the trademark rights, we are now taking the final step of integrating this process technology into our product portfolio," says Michal Prochazka, Managing Director of KEYCYCLE. This technology is a milestone in safely feeding back into the production process recycled pellets made from plastics that were originally printed. "The product not only delivers top quality, it now also meets industrial standards," explains Prochazka, referring to the new larger deinking line with a throughput of 1,200 kilograms per hour, an innova-

tion that was presented for the first time at K 2022. With plants on this scale, the KEYCYCLE deinking process also opens the door to the post consumer recycling segment, where the removal of printing inks enables another significant quality upgrade for the recycled pellets.

During the decolourisation process, the ink is dissolved from the surface of the shredded film or regrind material. Only water-based chemical components are used, which makes the deinking process particularly environmentally friendly. The material is then fed into the recycling extruder. Of the eight plants ordered since the market launch, five are now in operation at customers' sites, where they are delivering very impressive results.

The Cadel company continues to operate as Cadel Recycling Lab, dedicated to its core competence of developing new innovative technologies for plastics recycling plus laboratory and software techniques for decontamination assessment.



*Heavily printed film (left) is colourless following the deinking process (right) and as a result can be processed in the recycling extruder to make high-quality recycled pellets (bottom)
(Photo credit: EREMA)*

► KEYCYCLE GmbH
www.erema.at

New ULTRA 2200 Dryer Model

■ Maguire introduced the new ULTRA 2200 series dryer at K 2022 in Düsseldorf, Germany. The ULTRA 2200 is designed to meet the higher throughput requirements of central drying, sheet extrusion, preform, and fiber markets and offers much faster drying than conventional methods while using significantly less energy.

While the principal phases of the vacuum drying process remain the same as those of the existing ULTRA-150, ULTRA-300, ULTRA-600, and ULTRA-1000 models, the ULTRA-2200 utilizes a pair of identical multi-function chambers

The ULTRA 2200 Series dryer includes two vessels working in tandem so that you are never waiting for dry material in the operation



that alternate in sequence to provide an uninterrupted flow of dry material. Each chamber can self-load, heat, vacuum, and dispense. This design allows for a compact arrangement with a relatively low ceiling height requirement.

Maguire's first vacuum dryer, the LPD, launched in 2000. The patented design allowed users to dry materials via the application of vacuum and not by dry air as done with desiccant designs. This fast, modern and efficient process takes a fraction of the time and uses 60% less energy compared to conventional desiccant dryers.

Vacuum drying provides speed and efficiency to dramatically lower energy consumption compared to conventional desiccant dryers. While each system uses the same amount of energy to heat up the resin, the energy required to dry the material is significantly less – as there is no regeneration process required in vacuum drying. The result is dramatic savings that not only offer a quick return on investment but the ULTRA models pay for themselves year-after-year for the life of the dryer.

Maguire's ULTRA 2200 incorporates load cell technology which provides the operator the ability to monitor and control each step of the drying process allowing for process optimization throughout the entire drying cycle. By digitalizing the process, every granule within the drying system is actively monitored and controlled. The data can easily be viewed on the touchscreen and details of the exact operating process as it happens are logged, giving the user a clear understanding of how the material has been dried. In addition, all of this data is available for export for integration with any ERP or other process control systems.

Maguire
www.maguire.com

Breakthrough in Foam Extrusion

■ The new Microcell Technology from Promix Solutions will reduce raw material consumption in extrusion processes by up to 20 % without losing mechanical properties. Until now, the density reduction in physical foaming contributed to a certain loss of mechanical properties. This recent breakthrough has changed this and makes the technology even more attractive.

The secret of high-quality physical foaming lies in the cell structure. Tests have shown that very small and evenly distributed cells result in significantly improved mechanical strength. A foam with 50 µm cell size has 27 times more cells than a foam with 150 µm cell size (same density). This fact makes it understandable that the mechanical behavior of microcell foams is different. The key to achieve the small cells is a combination of various factors. The dispensing of the blowing fluids with very high precision and in supercritical stage, unique cooling and mixing equipment, special nucleation technology and further improved pro-

cess knowhow was required to achieve the next level of foaming.

Promix Microcell Technology works for all types of extrusion processes including packaging films, sheets and boards, pipes and profiles, cables, blown film and extrusion blow molding. The technology can be retrofitted to existing extrusion lines as well as installed in new lines. Promix is working with a number of machine builders to achieve a perfect match.

Promix Solutions AG
www.promix-solutions.com

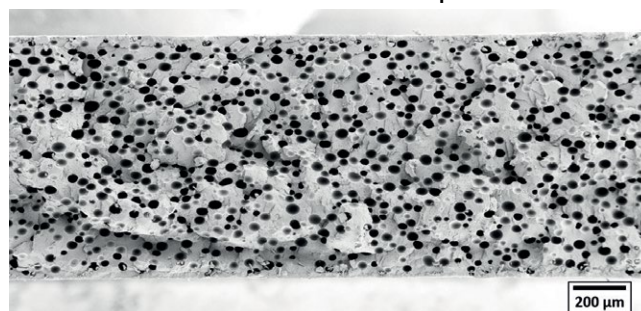

Promix Microcell foam structure with < 50 µm cells on the example of a PET film (Source: Promix Solutions AG)

Extrusion Die for the Production of Panels Made from Recycling Textile Fibers and Plastics

■ Circular economy is a concept that requires innovative ideas with strong partnerships to tackle the global challenge. Nordson has partnered with the European-based company, Greenful Group, to develop a system for the production of construction materials made from recycled waste.

The Greenful Group is a leader in the innovative recycling of textile, plastic, and other waste into new value-added building products that outperform traditional materials while at the same time improving the environment. Greenful targets to recycle 15% of Europe’s textile waste within the next 8 years.

“Greenful’s mission is to help solve the environmental waste crisis by transforming waste streams into products useful to society that also have an impact. We are proud to partner with Nordson, who is bringing circular solutions to the market that address these issues. Both our companies make sustainability a top priority and I believe that by working together we can make a big impact,” said Toomas Allikas, CEO of Greenful Group.

Nordson’s EDI® business will support this goal by providing an Ultraflex™ FastGap™ restrictor bar die to produce construction panels made from textile fibers and composite material. “The very high content of recycled material is a challenge,” says Sam Iuliano, Chief Technologist. “We need larger than normal clearance areas within the die so the fibers are not trapped, which can lead to blockage and sheet defects.”

Nordson has worked with Greenful to develop an engineered solution utilizing the company’s Multiflow™ I-R distribution manifold to ensure maximum streamlining. The extrusion die will include a series of lips to cover the desired product thickness range. “We are using extensive 3-D FEM simulations to be able to accurately distribute the material by utilizing our proprietary flow channel geometry,” explains Iuliano.

The extrusion die, scheduled for completion in 2023, will be installed in the laboratory of a Europe-based OEM for further product development by Greenful Group.

➔ Nordson Polymer Processing Systems
www.nordsonpolymerprocessing.com



EDI® Ultraflex™ Restrictor Bar Die with FastGap™ Lip Positioning System

Elevate Control Functionality with DS-XEL

■ Davis-Standard announced the release of its DS-XEL control system. This system, which replaces mature discrete controls, implements high-performance HMI features to better facilitate the data and process information requirements of today’s manufacturing environment. Attention is given to active functions for a better operator experience and improved connectivity. The DS-XEL will be the new standard control for Davis-Standard’s Super Blue® and HPE extruder lines and is compatible with the DS Activ-Check™ cloud-based platform. It is also available as an upgrade to existing extruder controls.

“This controller merges the latest PLC and HMI offerings to enable an operator-friendly package with greater attention to detail,” said John Clemens, Davis-Standard’s Director of Extrusion Controls. “It also incorporates key features only available with larger system controllers for troubleshooting and process improvement.”

The DS-XEL provides on-screen graphic trending of essential extruder parameters, visually tracking temperature, barrel pressure, motor speed and motor load. Speed deviation from setpoint is displayed along with an extruder maintenance run timer and heater zone alarms, indicating deviation, process temperature, power failure, heater load and sensor break. The minimum, maximum, and average

motor load is captured during each production run. Recipe creation and storage allows for repeatability of multiple products on the same line.

Other advantages include process alarm logging, real-time and historical data trending, auto and self-tuning of heat zones for quick die changes, and an on-screen display of individual zone heaters. In addition, the DS-XEL addresses connectivity requirements with a simple connection to ERP/MRP or upper-level supervisory control using a standard OPC-UA interface.

➔ Davis-Standard, LLC
www.davis-standard.com

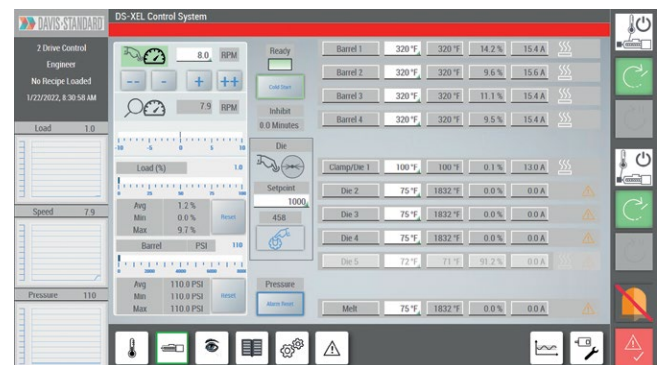

100% Inspection for Printing and Slitting Machines up to 1700 mm

■ The successful TubeScan digital strobe inspection system is now available in XL format for wide web applications on printing and slitting machines (slitters): BST's TubeScan XL inspects 100 percent of web widths between 900 and 1700 millimeters and detects even the finest of printing defects such as splashes, register deviations and color changes at high web speeds. This means less waste during printing processes, and effective quality assurance at the slitter. Thanks to its compact mounting frame made of extruded aluminum profiles, TubeScan XL can be integrated easily into new and existing machines.

TubeScan XL increases the productivity of printing and slitting machines by consistently providing the user with a complete overview of the current job in real time, including the precise amount of waste. This allows the machine to be stopped exactly when the job is completed. The presentation and interaction options can be grasped intuitively,

TubeScan XL can be installed on common printing and slitting machines. The system has a universal mounting frame with two built-in idler rollers, which can be pre-mounted in different ways depending on the web path



With BST TubeScan XL, wide web applications can now also benefit from cost-efficient and ultra-fast 100% print inspection

allowing operators to master the system quickly and safely even without advanced computer skills.

The highest standards for printing inspection are met by TubeScan XL, which can be placed on standard printing and slitting equipment. The system is available in two different configurations depending on the area of application.

On slitters, QLink workflow creates a defect log for each individual daughter roll, which the doctoring machine uses as a basis for eliminating defects. The degree of tolerance is set as a rule during job setup, and defines what types of deviations from the master image are considered defects. The QLink Slitter categorizes the inspected material into "defect-free," "waste" and "to be corrected" based on this rule. Relevant statistics for the daughter rolls are clearly displayed to the operator on the screen.

TubeScan XL has a universal mounting frame with two built-in deflection rollers. Depending on the desired web path, these deflection rollers and the encoder crossheads can be pre-assembled in different ways.

BST GmbH

www.bst.elexis.group

Chemical Recycling Provides Circular Solutions for Crosslinked Polyethylene

■ Borealis announces the capability to use its proprietary Borcycle™ C chemical recycling process to recycle crosslinked polyethylene (PE) types such as XLPE and PE-X into recycled polyethylene. Thanks to its suitability for high performance applications, the recycled PE obtained in the pyrolysis process can replace virgin PE in the manufacture of XLPE and PE-X for use in the Wire & Cable and Infrastructure industries, respectively. Using ISCC PLUS (International Sustainabil-

ity and Carbon Certification) certified grades in the Borcycle C portfolio enables customers to capitalise on circular solutions while at the same time maintaining high application quality and industry standards.

For cable networks, XLPE offers cost effectiveness and flexibility in installation. When used as insulation in low voltage electrical cables, XLPE boasts a better overall life-cycle impact than alternative materials: less of this lighter-weight mate-

rial is required to provide top cable system performance. PE-X is deployed in a wide range of advanced polyolefin plumbing and heating pipes, and is particularly suited for coping with demanding environments. Compared to conventional materials, the inherent properties of crosslinked PE-X offer distinct benefits, including exceptional toughness, chemical resistance and durability at high temperatures. Up until recently, however, it was dif-

difficult to recycle XLPE or PE-X in such a way as to obtain the virgin-like PE required for these high-performance applications.

By drawing on its polymers expertise and recycling know-how, Borealis can now offer its customers a circular solution for crosslinked PE. In a series of tests conducted by Borealis, XLPE and PE-X plastic waste were pre-treated and fed into the Borcycle C chemical recycling process. This chemically-recycled material was analysed and determined to be suitable for use as cracker feedstock in the production of new ethylene in the manufacture of virgin-grade XLPE and PE-X.



Borealis Borcycle™ C chemical recycling process breathes new life into crosslinked polyethylene (PE) types such as XLPE and PE-X (Photo: © Borealis)

The proprietary and evolving recycling technology Borcycle C transforms plastic waste streams into val-

ue-added products. These chemical recycling solutions complement mechanical recycling by turning difficult-to-recycle plastics – like crosslinked polyethylene – into virgin-level grade materials with the highest safety and performance characteristics.

Grades in the Borcycle C portfolio of circular polyolefins are ISCC PLUS certified according to the third-party mass balance methodology. This allows the customer to track and quantify the effective circular feedstock used at each step in the manufacturing process.

► Borealis AG

www.borealisgroup.com

Melt Filter for Blown Film Applications

■ Producing quality blown film is not an easy task. A film bubble reacts sensitively to changing process conditions, and only minor changes in temperature, viscosity, and especially pressure can have a negative impact. Existing filters provide the necessary process stability and deliver clean, homogenous melt for a high-quality blown film – when only virgin material is used.

But this won't be the case much longer. The social call for more sustainability in the plastics industry has led to new laws and regulations. Producers face tax penalties and other consequences if they don't increase their use of recycled material significantly. But adding recycled materials to the mix is an additional disruptor to an already delicate process. Depending on their size, contaminants can cause optical flaws and bubble ruptures, leading to line shutdowns.

"The change from using only virgin materials to including recycled material is huge and needs new, innovative technology to support that transition. But we like a challenge," says Christian Schroeder, Global Segment Manager for the recycling market at Nordson. "We developed a melt filter, based on our unique backflush technology, that enables the use of recycled material while keeping the process stable and the end product quality at the usual high level."

"Melt filters without a backflushing function have limits when processing recycled material. Contamination levels are high, and the screens clog fast," explains Stefan Woestmann, Process Specialist. "Screens are expensive, and the changing procedure is time-consuming. Through backflushing, the screens are cleaned from contamination and debris over and over, so

producers need fewer filter elements and operators need to perform fewer screen changes."

To cope with the high process pressures in blown film applications, Nordson made patent-pending changes to its already proven backflush technology. "It was important to us to remain pressure constant even under difficult conditions to ensure high film quality," reports Stefan Woestmann.

Pressure consistency is an essential component of operating a blown film line successfully. And in this high-pressure application, it is even more important to avoid pressure fluctuations through intelligent solutions. Each screen change is a sensitive step in the filtration process, as the empty cavity must be filled with melt again after the change. If this happens too fast, pressure fluctuations are likely.

"This is a significant issue in blown film lines since the film is usually very thin and reacts sensitively to such events," explains Woestmann. "The BKG® HiCon™ K-SWE-HD/RS melt filter is equipped with the patented melt pressure controlled venting start that fully automizes the filling of the screen cavity after a screen change for maximum pressure consistency. Additionally, the filling is done so carefully that no air entrapments endanger the process or the end product.

Producers can rely on a stable process and great quality of the blown film," explains Woestmann.

The processing of recycled material generates more waste than that of virgin polymers because melt is removed from the filter during backflushing and venting. The BKG® HiCon™ K-SWE-HD/RS melt filter is designed so that this happens in a clean and maintenance-friendly way. The safety cover can be opened vertically, allowing the operator to reach the filter piston from all sides, which facilitates cleaning.



► Nordson BKG GmbH

www.nordson.com

Call for Nominations for 'Thermoformer of the Year' Announced

■ The Society of Plastics Engineers (SPE) Thermoforming Division has announced a call for nominations for the annual Thermoformer of the Year Award. The award recognizes an individual who has made a significant contribution to the thermoforming industry in a technical, educational or managerial capacity.

The nomination deadline is March 31, 2023. Nominees will be evaluated and reviewed by the SPE Thermoforming Division Board of Directors during its Spring Board Meeting in late May. An announcement on the winner will be made following this meeting.

The award will be presented during SPE's Thermoforming Conference Awards Gala, held on October 25th in conjunction with the 29th

SPE Thermoforming Conference. The conference will take place October 23-26, 2023 in Cleveland, OH, at the Huntington Convention Center.

"The Board is seeking candidates who have led exemplary careers and have contributed to and nurtured the growth of the thermoforming industry," said Juliet Goff, SPE Thermoforming Division Board Member and Recognition Committee Chair.

The 2021 Thermoformer of the Year award was received by Hal Gilham, former President of Productive Plastics.

Guidelines for nominees and the required nomination form are posted online at <http://thermoformingdivision.com/awards-recognitions/thermoformer-of-the-year/nomination-form/>. All materials must be



THERMOFORMING

emailed to Juliet Goff at juliet@kal-plastics.com by the March 31 deadline.

Past recipients of the Thermoformer of the Year Award may be found on the SPE Thermoforming Division website at <https://thermoformingdivision.com/awards-recognitions/thermoformer-of-the-year/past-winners/>.

More information is available at <https://thermoformingdivision.com>

HPE Extruder and New DS-XEL Control to Drive Running Pipette Line at MD&M West

■ Davis-Standard's medical extrusion expertise and customer-centric approach promoted during MD&M West 2023 in February this year. Show visitors had an opportunity to view a running polycarbonate pipette line equipped with a Davis-Standard HPE (high performance) extruder and new DS-XEL process control. The line also featured downstream equipment from the Conair Group and an OD/ID/Wall gauge system by Zumbach Electronics, both Davis-Standard technology partners. In addition, a 2.5-inch (50mm) Davis-Standard Super Blue® extruder was displayed with DS-XEL controls, and customers could learn more about the company's DS Activ-Check™ cloud-based platform for preventative maintenance and monitoring.

The DS-XEL, introduced last fall, implements high-performance HMI features to better facilitate the data acquisition and process information required for today's manufacturing. Processors benefit from built-in

security to prevent unauthorized changes to system set-up parameters, multi-language support, process alarm logging, and real-time and historical data trending. In addition, visual attention is given to active functions for a better operator experience and improved connectivity. The DS-XEL is the new standard control for Davis-Standard's Super Blue® and HPE extruders.

Davis-Standard's HPE extruder powers the line. This extruder is available in an adjustable vertical or horizontal configuration in sizes ranging from ¾-inch (19mm) to 1 ¾ inches (44mm). A direct coupled motor and smaller footprint make this machine ideal for tight manufacturing spaces and clean-room environments. The HPE can be run as the primary

extruder, or as a complementary extruder in a coextrusion arrangement. The Super Blue® is easy-to-maintain, energy-efficient, and provides increased torque capacity for high-viscosity resins. It is available

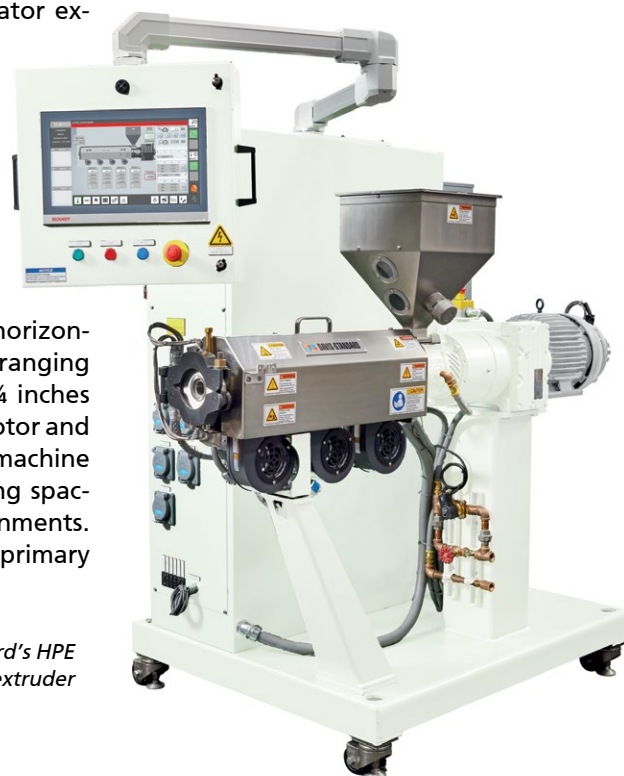

Davis-Standard's HPE (high performance extruder) extruder

in sizes from 2 inches (50mm) to 4 1/2 inches (114mm) with a range of DSB® barrier screw designs and a three-year warranty.

"We continue to expand upon our medical tubing solutions targeted at energy efficiency, sustainable practices, and process versatility to address evolving resin and end-product requirements," said Kevin Dipollino, Davis-Standard's Senior Product Manager of Pipe, Profile and Tubing Systems. "We have had excellent feedback on the DS-XEL, and can engineer this system to accommodate our DS Activ-Check™ digital transformation tool in order to achieve overall equipment effectiveness (OEE)."

DS Activ-Check™ is gaining traction as a smart manufacturing so-

lution due to its many advantages, such as real-time monitoring, predictive and preventative maintenance, process and equipment analytics, and multi-faceted team connectivity. Processors can apply DS Activ-Check™ to amplify production efficiency, easily connect and collaborate using smart devices and remote PCs, manage cloud-based data collection, improve operator productivity and safety, and accelerate service and support.

Davis-Standard provides multiple services aimed at strengthening product line performance. This includes die reconditioning, feed-screw replacement to boost outputs and material homogeneity, control system upgrades to enhance digitalization and product changeover,

and more! Feasibility studies are available for existing lines to address outputs, resin changes, product development, and more. An extensive spare parts inventory and regional vendor network help minimize supply chain delays.

"Consistent product quality, sustainable manufacturing, and reduced waste directly impact the bottom line," added Dipollino. "Whether it's medical tubing, medical packaging, materials for hygienic products, or other markets, we seek to deliver value-added equipment technology and timely aftermarket services to each of our customers."

► Davis-Standard, LLC
www.davis-standard.com

Reduction of Air Emissions with New Technology

■ Orion Engineered Carbons said it will sharply reduce air emissions at its Borger, Texas, plant with new control technology.

The \$60 million project also involved upgrading the site's cogeneration system, which takes heat created by the carbon black production process and converts it to electricity that can be used by the plant. The electricity is also sold back to the power grid. Such energy conser-

vation equipment is used by many Orion plants worldwide.

"Investing in emissions control technology and generating more clean energy are key to our commitment to sustainability," Orion CEO Corning Painter said. "I want to commend our engineers, the Borger team and our contractors for the timely completion of this complex project despite the Covid-19 pandemic and supply chain disruptions."

The new emissions technology will lead to a major improvement in air quality, eliminating 23 tons of nitrogen oxide and sulfur dioxide emissions per day – a 90% reduction. The Borger plant produces carbon black for rubber and specialty clients.

Orion also recently upgraded its emissions control technology at facilities in Ivanhoe, La., and Orange, Texas. Later this year, Orion plans to finish its final U.S. emissions project at its site in Belpre, Ohio.

"We are proud that we've upgraded these plants, but it was an extremely demanding undertaking," Painter said. "As we complete the Belpre project, Orion will have significantly more free cash flow to invest in growth proj-



ects. 2023 marks a new era for the company."

Upgrading the Borger plant supports Orion's efforts to achieve the targets in its sustainability-linked term loan. Last year, Orion was one of the first public companies to take out such a loan, which has interest rates that go up or down depending on whether a company meets specific environmental, social and governance goals.

► Orion Engineered Carbons
orioncarbons.com



„GLOBAL TRENDS REPORT“ Released

■ The Plastics Industry Association (PLASTICS) released its annual Global Trends report during an executive briefing at the K Show in Düsseldorf, Germany in October, 2022.

“Inflation was a big factor in the increases in the dollar value of exports and imports of plastics trade,” said Perc Pineda, Ph.D. Chief Economist at PLASTICS. “While this year’s merchandise trade outlook could miss the forecast, as the global economic growth slowed, the world is still the market for the plastics industry.”

Among the highlights found in the Global Trends report:

- The U.S. plastics industry’s overall trade deficit grew to \$10.1 billion in 2021 from \$5.4 billion just a year earlier. For several years prior, the plastics industry enjoyed a trade



Matt Seaholm

surplus. Still, the U.S. enjoyed a \$19.6 billion surplus in resin.

- The U.S. plastics industry had an \$18.2 billion trade deficit with China, its third-largest export market. This was, however, offset in part by an \$2.6 billion resin trade surplus with China, the world’s largest resin buyer and a large importer of U.S.-produced resins.

Interested parties throughout the globe will find the „Global Trends“ report and its accompanying dataset provide a comprehensive account of U.S. plastics exports and imports worldwide in each of the four categories of the plastics industry – resin, products, machinery and molds. The report is also the only plastics trade report that includes contained trade analysis outlining the movement of resins and plastics that are embedded in goods that the U.S. both exports and imports.

- According to Global Trends, Mexico and Canada remained the U.S. plastics industry’s largest export markets. In 2021, the industry exported \$18.0 billion to Mexico and \$15.0 billion to Canada, maintaining its largest trade surplus – \$10.8 billion – with Mexico.

- In the first half of 2022, U.S. plastics industry exports increased 16.9% and imports rose 17.0% compared to the first half of 2021. The trade balance however, increased by 17.4%.



Perc Pineda

“Risks on plastics trade remain in the forecast for 2023, but for the U.S. plastics industry, international trade remains a component of its overall growth strategy in 2022 and beyond,” said Pineda. “The U.S. ranks second in PLASTICS Global Plastics Ranking™.”

“The fact that our Global Trends report anticipates positive results for our industry, despite a widened trade deficit, speaks to the importance of plastics to the world we live in,” said Matt Seaholm, President and CEO of PLASTICS. “Our members stand ready to provide the materials that improve lives throughout the world and that are essential to creating the circular economy we all strive to achieve.”

An executive summary of PLASTICS’ Global Trends report is available online at:

➔ www.plasticsindustry.org/globaltrends

2022 Industry RECAP Provided

■ PLASTICS has released “The U.S. Plastics Industry in 2022 in Seven Charts,” a recap of the plastics industry 2022 economic performance, authored by Chief Economist, Dr. Perc Pineda. Dr. Pineda writes, “Seven charts explain how the U.S. plastics industry, throughout the supply chain, performed

in 2022. The U.S. plastics industry continued to grow in 2022 against the backdrop of weaker domestic and global economic growth. Data shows that the U.S. economy’s output contracted in the first half of 2022 and followed by what appears to be a tepid output growth rate in the second half of 2022. The

manufacturing sector — plastics industry included — continued to adjust to domestic and global economies that have started to downshift into a lower gear this year.”

➔ www.plasticsindustry.org/blog/us-plastics-industry-2022-seven-charts

2023 Recycling Committee Executive Board Announced

■ PLASTICS has announced the 2023 Recycling Committee Executive Board. The Recycling Committee is a tactical committee that rep-

resents PLASTICS’ members across the association’s four councils, bringing equipment makers, brand owners, processors, and material

suppliers together aligning their collective efforts to put recycling at the forefront of their business priorities.

The PLASTICS Recycling Committee works to enhance the management of plastic waste through efforts such as advocating for increased collection, sortation, and recycling infrastructure, ensuring that the definition of "recycling" includes advanced recycling, educating people within and outside of the plastics industry about plastics recycling, and much more.

"PLASTICS relies on and values leadership from our members," said Andy Brewer, PLASTICS' Associate Director of Sustainability and Materials. "We are excited to announce the 2023 Recycling Com-

mittee Executive Board, with expert professionals that represent the entire plastic supply chain."

The Recycling Committee's 2023 Executive Board is as follows:

- *Chair:* Tory Flynn, Hillenbrand
- *Vice Chair:* Melanie Bower, ExxonMobil
- *Member at Large:* Lindy Holland, M. Holland
- *Member at Large:* Jean Jordan, Nexus Circular
- *Member at Large:* Ray Pellerin, EREMA
- *Advanced Recycling:* Holli Alexander, Eastman

- *Advocacy & Communications:* Christine Cassidy, Dart
- *Events & Education:* John Cook, Niagara Bottling
- *New End Market Opportunities:* Dan Sanders, Printpack
- *Immediate Past Chair:* Kevin Cronin, Ultra-Poly Corporation

The Recycling Committee Executive Board is comprised of ten members, voted upon annually by committee members, and elected to provide thought leadership for PLASTICS and throughout industry.

2023 Cleanup Champions

■ PLASTICS has announced its list of 2023 Cleanup Champions. Lead by the Future Leaders in Plastics (FLiP) Community Impact Task Group, the Cleanup Champions Initiative encourages PLASTICS' member companies to use the *Guide to Planning a Litter Cleanup* to carry out a cleanup in their community in 2023. Each of these companies are dedicated to making a difference in their communities by working to eliminate plastic and all material waste from the environment.

"PLASTICS and the entire plastics industry are dedicated to recycling, eliminating waste from the environ-

ment and making change for good in our local communities," said Heather Nortz, PLASTICS' Sustainability and Materials Manager. "PLASTICS' 2023 Cleanup Champions have committed to giving back to their community and positively impacting our environment. We are excited to see what PLASTICS' 2023 Cleanup Champions will accomplish this year."

The 2023 Cleanup Champions are:

- Advanced Blending Solutions
- Brueckner USA
- Industrial Heater Corporation
- Braskem
- Covestro
- Epsilyte

- Milliken
- Gardner Business Media
- Dart Container
- Colour Synthesis Solutions
- Placon

The Future Leaders in Plastics (FLiP) Community Impact Task Group was created in April of 2022 to foster collaboration among PLASTICS member companies and external organizations to provide an outlet for the industry to give back and positively impact the environment and communities the plastics industry serves.

➔ www.plasticsindustry.org

Inaugural ESG Report Released

■ SI Group has released its inaugural Environmental, Social, and Governance (ESG) Report. The report demonstrates SI Group's commitment to sustainability and defines its future targets as it elevates efforts to improve its social responsibility.

This is SI Group's first ESG report and serves to illustrate its ongoing work and performance across five key areas:

- Climate change and environmental impact
- Safe operations
- Sustainable procurement
- Innovation and business practices

- Diversity, equity, and inclusion (DEI)

The report has been developed in accordance with Global Reporting Initiative (GRI) standards and celebrates SI Group's current accomplishments in these areas. It also features SI Group's ambitious ESG targets, outlining the key metrics it plans to meet as it builds on its continual progress in this area. From striving for zero injuries and environment releases to prioritizing a more inclusive workforce, SI Group is using the report to unveil its vision for the future of the business.

"We are proud of our sustainability achievements. This report reflects credible progress in sustainability on our journey to becoming the global performance additives powerhouse," said David Bradley, President & CEO. "SI Group's drive for continuous improvement, paired with our commitment to sustainability as a fundamental component of our mission, positions SI Group to meet or exceed our ambitious targets."

➔ SI Group
www.siigroup.com
www.siigroup.com/sustainability

CHINAPLAS 2023 – *Packing in Industry Opportunities with RCEP*

Asia's Regional Comprehensive Economic Partnership (RCEP), the world's largest free trade agreement (FTA) enforced in January 2022, offers a bountiful of opportunities for the plastics, rubber and petrochemicals sectors in various aspects, giving Asia's advanced and emerging markets a much-needed economic boost.

Rebound of Asia's economy

Asia's trade growth was severely impacted by the pandemic. Slower growth and rising prices, as well as lower demand from recession-ravaged United States, China, Europe, and other trade partners, have also affected growth in Asia. Nonetheless, the region's GDP is expected to grow by 4.4% in 2022 and rise to 4.9% by 2023, according to the International Monetary Fund (IMF) 2022 regional economic outlook data.

Thus, bolstering trade is a strategy that is expected to accelerate recovery. FTAs signed by Asia's advanced and developing economies, as well as emerging markets, provide a much-needed economic boost for the region.

The Association of Southeast Asian Nations (ASEAN), which represents a market of more than 600 million people with a total combined GDP of US\$3.2 trillion in 2019, has seven trade agreements, including the Regional Comprehensive Economic Partnership (RCEP), which was signed in November 2020 and took effect in January 2022.

RCEP is a free trade agreement (FTA) between the ten member states of ASEAN (Brunei, Cambodia, Indonesia, Laos, Malaysia, Myanmar, the Philippines, Singapore, Thailand, Vietnam) and its five FTA partners (Australia, China, Japan, New Zealand and Korea). It is the world's largest FTA, covering 30%



RCEP aims to align ASEAN's existing FTAs and partnerships with the other five partner economies in a bid to reduce trade barriers and improve investment regulations

of the world's GDP and population, as well as approximately 30% of total global trade, and is the first FTA among the largest economies in Asia Pacific.

Currently the world's fifth largest economy, ASEAN is expected to become the world's fourth-largest economy by 2030, with a consumer market worth more than US\$4 trillion. This expansion will be aided further by RCEP. For example, RCEP members account for 40% of ASEAN's investments, while non-ASEAN RCEP members account for 24%.

Reinforcing the plastics value chain; a win for petrochemicals

The plastics value chain has been subjected to a number of disruptive events, prompting Asian companies and businesses to implement strategies to make their business models resilient to supply chain disruptions.

The RCEP's trade liberalization and preservation of multilateral trading systems can generate different trade opportunities for ASEAN

and non-ASEAN member countries, thereby accelerating the region's economic recovery.

Petrochemicals, which are essential in the production of raw materials such as polymers used in packaging, electronics, construction and other applications, are expected to trade strongly within the RCEP alliance.

Notwithstanding the supply disruptions and geopolitical volatility, the International Energy Administration (IEA) predicts that the petrochemicals sector will secure more than a third of global oil demand growth by 2030 and nearly half of demand growth by 2050.

China is one factor expected to influence this growth. The colossal country is expected to generate significant petrochemical demand, rising to 780 million tonnes per year by 2030, according to the NPC Economics & Technology Research Institute (ETRI).

Meanwhile, Thailand's petrochemical industry, which is the larg-

est in ASEAN, satisfies demand for petrochemical feedstock, such as naphtha and olefins, particularly in China, which is its largest export market, says Kungsri Research.

Healthy market growth for medical polymers

The global health crisis that affected the supply of personal protective equipment (PPE) and diagnostic health products, which are abundantly made of plastics or rubber, in the previous years has brought access to medical devices to the forefront more than ever before. RCEP is envisioned to enhance market access and ease the flow of provisions like medical devices.

Asia, the largest producer of pharmaceuticals and medical equipment, is expected to grow at a CAGR of 4.4% from 2022 to reach approximately US\$225 billion in 2030, with Thailand, Singapore, Malaysia, and Indonesia as revenue drivers and zones for investment and business opportunities.

The Indonesian medical device market is set to be among the fastest growing in Asia, with a market value of US\$1.9 billion by 2026. Singapore remains Indonesia's most important medical device export market destination, accounting for 41.5% of medical device exports in 2020, while Japan is the country's fourth largest market, accounting for 3% of the market share.

Thailand, the largest exporter of medical devices in ASEAN, has an ample supply of raw materials such as rubber and plastic used in the production of medical devices, particularly single-use items.

An estimated 41.8 million vehicles will be sold in RCEP countries by 2030, accounting to 46% of global market share



The global health crisis affected the supply of personal protective equipment (PPE). RCEP is envisioned to enhance market access and ease the flow of provisions like medical devices

In 2020, Thailand's medical devices sector generated an export value is US\$13.9 billion, outpacing Singapore (US\$13.08 billion), Malaysia (US\$12.1 billion), Indonesia (US\$4.1 billion), and the Philippines (US\$0.83 billion).

Harnessing ASEAN's automotive competence

Because of the region's burgeoning consumer market, integrated supply chains and comparatively lower cost of labor, the ASEAN automotive sector has emerged as a manufacturing hotspot for both OEMs and vehicle parts suppliers.

The automotive sector's inclusion in the RCEP is deemed to be complementary. According to the University of Duisburg-Essen's CAR Institute, an estimated 41.8 million vehicles will be sold in RCEP countries by 2030, accounting for 46% of global market share, and counting.

The huge potential brought by RCEP bodes well for the plastics and rubber sectors, as the automotive industry is the third largest user of plastics after packaging and construction, and a major consumer of rubber.

Thailand, which is Asia's automotive node, plays a key role in the automobile value chain. Several global companies have established facilities in the country for development,

design, and other production-related activities since the 2000s.

Unlock the RCEP opportunities at CHINAPLAS 2023

To unlock the RCEP opportunities, CHINAPLAS 2023 will bring together the most innovative plastics and rubber solutions and relevant market trends in one place with an exhibition area of 380,000 sqm under the theme of "A Brighter and Shared Future, Powered by Innovation".

By returning to Shenzhen, the gateway city to RCEP and the thriving innovation and technology hub in Southern China, CHINAPLAS shall converge different end markets and quality suppliers to foster collaborations and inspire innovations. Buyers from all over the world shall discover a well mixture of global and Chinese technologies, covering a wide range of application industries that are transforming the end market.

The Online pre-registration to CHINAPLAS 2023 is open till April 11, 2023. Visitors can enjoy an early bird discount at RMB 50 or USD 7.5 (Original Price: RMB 80) for a four-day pass.

Adsale Exhibition Services Ltd.
www.ChinaplasOnline.com

17 - 20 April, 2023,
Shenzhen / PR China

Solutions for an Eco-friendly and Sustainable BO Film Production

Brückner's show highlights pave the way for future processes and applications.



In addition to the developments for the rapidly developing circular economy, Brückner Maschinenbau is also sticking to its ambitious goals for further increasing efficiency in film production. This means decreasing use of raw materials, ever lower energy consumption and "zero waste" in film production. At Chinaplas 2023 in Shenzhen, latest solutions for the film stretching of the future will be presented in Hall 10, Booth 10Q21.

Higher efficiency – lower energy consumption

The more efficient and higher output a film stretching line is, the lower the specific energy consumption. These parameters can mainly be influenced by the line speed and the line width. At Chinaplas Brückner Maschinenbau will present corresponding new

line concepts for packaging film production:

- Production of the most popular packaging film BOPP with a line concept with an annual output above the current benchmark of 60,000 to 70,000 tons per year. This also means a two-digit lower energy consumption, based on 1 kg of film.
- BO films made of polyamide (BOPA): New line types with up to 80% more output – based on an increase in production speed from 220m/min to 350m/min and line widening from 6.6m to 7.4m.

More sustainability in film production

- A new type of direct recycling saves energy, conserves raw material and comes very close to the goal of "zero waste" in production.
- Intelligent stretching oven management ensures an energy

Brückner Battery Separator Film Production Line

saving of around 1.6 million kWh per year.

- Aerodynamic zone separation increases the proportion of A-grade film on the winder, reduces production waste and lowers specific energy consumption.

Mono-material films – solutions for a Circular Economy:

Mono-material solutions are ideal for the use in new applications since they guarantee good sortability in waste separation and high-grade recycling material quality. Brückner Maschinenbau has developed mono-material packaging solutions to close the life cycle of plastic packaging. Besides the



Brückner film stretching line

state-of-the-art materials BOPP and BOPET, a new opportunity is opening up with BOPE.

- Several developments for PP mono-material packaging have been successfully launched recently: E.g. flexible pouches, where complex laminates are now substituted by all-polypropylene versions based on BOPP and CPP or even retortable applications.

- Trials on the Brückner laboratory line clearly showed that post-consumer waste recylate PET can be added to the virgin material in a proportion of above 50% without any losses in quality.

Brückner film stretching line

- Line concepts for the production of BOPE films, also having the flexibility to produce BOPP films. Film producers can choose lines between a working width of 6.6 m and an output of 3 t/h, or a working width of 8.7 m and an output of 5 t/h.

Specialty film lines: Further developments

Special film lines from Brückner are in great demand worldwide, especially for the rapidly growing e-mobility and new energy sector. The patented simultaneous LISIM stretching process is ideally suited for the very efficient production of a wide variety of specialty films with the best properties:

- Battery separator films and capacitor films: In these segments, a further increase in the previous line width from 5.5m to over 6m and the associated increase in output of over 20% will take place in stages.

- Green energy solutions are supported by Brückner's special BOPET thick film lines, producing high performance solar backsheet used for photovoltaic panels.

- Industrial films for a wide variety of applications: Insulating film, composite films, electrical enclosures for cables and wires, membrane switches in motors and transformers, window film, protection and release film, motor insulation film.

- Flexible and printed circuits and electronics: Substrates for RFID antennas, organic displays, organic photovoltaic, medical sensors, printed batteries.

Brückner Maschinenbau GmbH & Co. KG
 Königsberger Str. 5-7,
 83313 Siegsdorf,
 Germany
www.brueckner.com



*Brückner Maschinenbau
 at Chinaplas 2023:
 Stand 10Q21*

Innovative Degassing and Decontamination Technologies for Demanding Recycling Applications

Gneuss presents new series of OMNI Recyclina Machines

Extrusion Technology

New OMNI Recycling Machines for closed loop recycling of PET, PS and polyolefin post-consumer reclaim

Gneuss' MRS Extrusion Technology has proven itself as an alternative for the reprocessing of contaminated materials like polyester, polystyrene, polypropylene or polyethylenes. In combination with the highly efficient Gneuss Rotary Filtration Systems and optimized vacuum technology, customizable recycling lines tailor-made for a specific material can be engineered. Several Letters of Non Objection (LNOs) from the FDA, EFSA conformity and local approvals in Latin America confirm the decontamination efficiency of the technology.

OMNI Recycling Machine for post-consumer fiber or thermoform reclaim

Gneuss will show its latest machinery innovations for today's and tomorrow's recycling needs with the new OMNI Recycling Machines.

The OMNImax Recycling Machine processes industrial and post-consumer waste from all kinds of polymers and in all forms and shapes. It includes a 3C Rotary Feeder, an

Picture 2: OMNIboost Recycling Machine with JUMP polyreactor, MRS Extrusion System, Rotary Filtration Systems and 3C Rotary Feeder

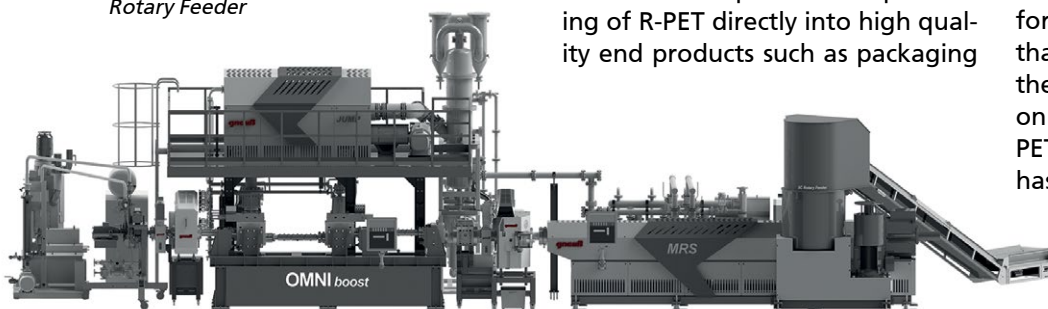

MRSjump extruder, a fully automatic melt filtration system RSFgenius and an online viscometer VIS.

3C Rotary Feeder

The newly developed 3C Rotary Feeder makes it possible to use low bulk density materials without any external processing steps. A conveyor belt feeds shredded reclaim material into the hopper, where a fast-rotating disc with knives cuts, compacts and pre-conditions the material. The knives add energy into the material and start the heating and degassing process before the material is automatically fed into the MRSjump extruder.

MRSjump

The MRS extruder is based on conventional single screw technology but is equipped with a multiple screw section for devolatilization. It enables very efficient and gentle decontamination of PET, whilst achieving the requirements for direct food contact standards. The MRS extruder permits the processing of R-PET directly into high quality end products such as packaging

Picture 1: Gneuss OMNImax Recycling Machine with MRSjump Extrusion System, Rotary Filtration System and 3C Rotary Feeder

sheet, strapping tape or filaments without pre-drying by using a simple and rugged vacuum system. This is achieved by means of its unique and patented processing section. The Multi Rotation Section is a drum containing multiple satellite single screws, driven by a ring gear and pinion transmission.

The satellite screws rotate in the opposite direction to the main screw. This disproportionately increases the surface exchange of the polymer melt. A large opening for venting, exposing the full length of the satellite screws, is completely under vacuum. This provides excellent and unrestricted access to the polymer melt, the surface of which is constantly replaced at an extremely high rate by the action of the satellite screws in the multiple screw section. The surface area – and the surface area exchange rate – available for devolatilization are far greater than in other extrusion systems. As the thermal and mechanical stress on the polymer melt is minimized, PET processed on the MRS extruder has excellent optical and mechanical properties.

The new MRSjump has a longer, modified version of the Multi Rotation Section, which

ensures both a longer residence time of the material and more surface area exchange under vacuum. The longer Multi Rotation Section, coupled with a powerful vacuum system operating at 1 mbar, can be used to boost the viscosity of R-PET and to hold it at a stable level in spite of variations in the input material. Therefore, there is no need for any liquid phase (LSP) or solid state polymerization (SSP). With the stabilization and/or increase of the intrinsic viscosity in the extrusion process, the MRSjump is especially well suited to recycling e.g. PET film waste or fiber reclaim – applications for which direct recycling with one single extrusion step was previously impossible due to low intrinsic viscosity or variable input viscosities. In combination with Gneuss' Rotary Filtration Technology, a high melt purity is guaranteed. Quality assurance can be provided with an online viscometer VIS for measuring melt viscosity.

As demand for PET bottle flakes outpaces supply and processors are looking for alternative feedstock (e.g. to fulfill recycled content mandates) the MRSjump offers an excellent solution for PET thermoform, film or fiber recycling, while the newly developed MRS cutter compactor makes it possible to use low bulk density materials.

OMNIboost Recycling Machine including polyreactor JUMP

The OMNIboost Recycling Machine with an polyreactor JUMP processes PET waste, whether from industry or postconsumer, directly into high-quality products.

Picture 4: Gneuss sensors with digital gauge monitoring



The integrated JUMP can lift the IV value of a PET melt up to 0.95 dl/g.

In the JUMP the polymer passes over several slow turning elements which create a polymer film, the surface of which is constantly renewed. The reactor vessel is kept under vacuum, through which volatile substances are reliably removed. By regulating the residence time in the reactor, the vacuum, the fill level and the speed of rotation of the agitating devices, the polycondensation reaction can be altered to achieve the required product properties. The JUMP is a robust and reliable liquid state polycondensation system (LSP) and a compact, quick and efficient alternative to conventional solid state systems (SSP). It enables direct re-introduction of the polymer into the production process without the need to remelt the PET.

Filtration Technology

Tailor-made retrofits of pressure- and process-constant Rotary Filtration Systems

The continuous Rotary Filtration Systems are characterized by a filter disk on which the screen cavities are located in a ring pattern. Screens can be changed on the part of the filter disk that is not active in the melt channel, while the production process continues to run without any interruptions or disturbances.

Gneuss' top model, the RSFgenius, operates with an integrated back-flushing system offering self-cleaning for very demanding applications and highest quality requirements. Screens can be auto-

matically re-used up to 400 times and filtration finenesses below 10 microns/1200 mesh are available.

Retrofitting a fully-automatic RSFgenius to an existing extrusion line, whether in a pelletizing, sheet, fiber or pipe application, permits the use of more contaminated (and often cheaper) material and/or the use of finer screens. Every retrofit is tailor-made and usu-



Picture 3: Patented Rotary Filtration System RSFgenius

ally without the need to move any existing equipment.

Measurement Technology

Measuring Technology for Extrusion – Flexible, Fast, Safe, Digital

Gneuss provides flexible sensor solutions for pressure and temperature measurements, individually tailored to your application. Abrasion, corrosion, temperature, Gneuss offers the right solution for every challenge.

Gneuss delivers fast. Whether standard sensor or application-specific customized solution. The flexible manufacturing structure allows shortest delivery times.

Gneuss creates safety. In addition to standard-compliant pressure monitoring, Gneuss offers the necessary quality assurance of the measuring equipment.

Gneuss is digital. The latest generation of Gneuss sensors and pressure monitors communicates completely digitally. Integrated RFID chips for digital gauge monitoring are available for all sensor models.

➔ Gneuss Kunststofftechnik GmbH
Moenichhusen 42,
32549 Bad Oeynhausen, Germany
www.gneuss.com

Gneuss at Chinaplas 2023:
Stand 10H31

With Pump & Filtration Systems, Pelletizing & Pulverizing Systems, Recycling Systems and Digital Solutions at CHINAPLAS

More and more new developments in plastics are being made in China, one of the strongest growth markets in the world. MAAG Group takes this into account and will be present at Chinaplas in Shenzhen, China, from April 17-20, 2023 in the German Pavilion in hall 10, booth No. F11.

The MAAG experts on site will be happy to inform the visitors about their product portfolio for the polymer industry:

- The MAAG Group **extrex®** gear pumps GA are designed for common thermoplastic extrusion applications and offer a high overall efficiency and hence minimum abrasion due to leading gear and bearing technology. They convince with low pulsation pump action also in cases of high differential pressure and a simple and compact design. With over 15'000 MAAG gear pumps installed in China, you know that you have competence on your side.

The newly developed **extrex®** recycling pump ensures reliable extrusion in the recycling process. The **extrex®** features an optimized geometry that, in many cases, eliminates the need for an upstream protective filter, saving space and reducing the energy required for heating and drive power. Like all MAAG pumps, **extrex®** is designed to meet the high demands of everyday operation.

- MAAG ETTLINGER ERF 350 is a high-performance melt filter for the filtration of heavily contaminated polymer feedstock. The filter is self-cleaning with a rotating, perforated drum, through which there is a continuous flow of melt from the outside to the inside. A scraper removes the contaminants that are held back on the surface and feeds them to the discharge system. This enables the filter to be used fully automatically and without any disruptions over long periods without having to replace the screen. The advantages: Reliable melt filtration, ultra-low melt losses and good mixing and homogenizing of the melts.

- The BAOLI-3 strand pelletizer is outfitted with German-made core components and has been designed

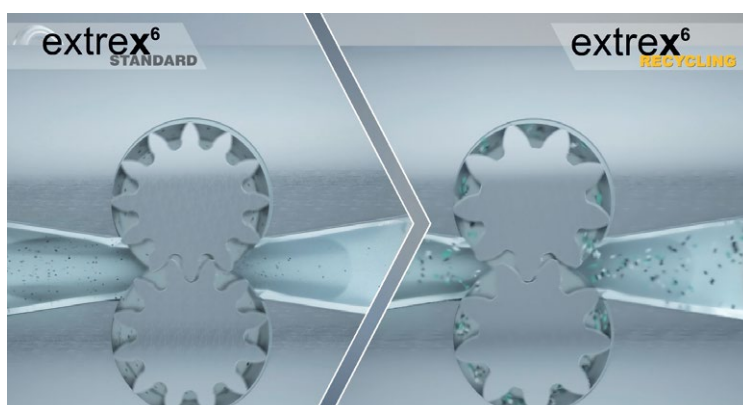

Comparison of extrex6 standard pump and extrex6 recycling pump: MAAG's melt pump has been specially upgraded for processes dealing with higher contamination levels and larger particles on the recycling market

for use with both hard and soft pelletizing materials. The most noteworthy highlights are its compact design that features height-adjustment, left-side/right-side control capabilities that provide greater operational flexibility, and reduced noise generation during operation. At the same time it offers easy access for cleaning making it easy for maintenance, material changes, and color changes. The BAOLI-3 pelletizer is based on MAAG's more than six decades of experience and an installed base of nearly 1'000 BAOLI pelletizers in China to develop a new and enhanced version which provides high reliability, improved handling, and an optimized cost/benefit ratio.

- The ZHULI® system is a highly flexible, cost-efficient underwater pelletizing system designed for use with standard products, such as filled Polyolefins, Polyesters and Thermoplastic Elastomers. ZHULI®'s cutting tools deliver spherical pellets of the highest quality that are ideally suited for further processing, with throughput rates of up to 1,200 kg/h. The pelletizing system has a small footprint and is simple to operate.



BAOLI®-3 – Highly reliable strand pelletizer with countless references

Maag Pump Systems AG
Aspstrasse 12, 8154 Oberglatt,
Switzerland
www.maag.com

YOUR BENEFITS:

- MORE ATTRACTIVE PROFILE SURFACES
- MORE PRECISE GEOMETRIES OF THE PROFILES
- LOWER INPUT AMOUNT
- LESS ENERGY CONSUMPTION
- MORE STABLE PROCESS
- MORE RELIABILITY
- GREATER SYSTEM AVAILABILITY
- LONGER NET PRODUCTION TIMES
- EXPERIENCED SPECIALISTS FOR PROFESSIONAL SOLUTIONS AND EXCELLENT SERVICE

Getting the Most from Your Extrusion Tooling

By: Glen Guillemette,
President Guill Tool & Engineering

Tooling maintenance improves extrusion efficiency, enhances quality and boosts overall productivity for your medical tubing applications.

By utilizing state-of-the-art production equipment and processes, machining tolerances are held extremely close on today's multi-lumen and multi-layer medical tubing. It is important to note that any misalignment of the tools may be exaggerated in the final product output. Clean parts, especially with sealing and locating surfaces, are key to product performance and successful end products. These surfaces receive the most care and attention during manufacturing and are the control surfaces that ensure uniformity throughout the tubing. Remember, precision-machined alignments are affected by even a speck of dirt measuring only a few thousandths of an inch. A human hair is about 0.003" (0.08 mm), and since there are many such surfaces in a quality tool, cleanliness is critical.

Checking of the tools for any deformities is also important. Burrs, scratches and scrapes are usually a result of careless handling and/or storage of equipment. Double and triple-layer extrusion heads pose an even greater challenge for maintenance. The number of seal-

ing and centering surfaces multiplies and can magnify the results of dirty tools. During changeovers, the head may be disassembled in order to change compounds and/or tips and dies. Foreign matter is usually introduced at this point and residual materials must be thoroughly removed. Physical tool damage often occurs during this phase, due to mishandling and poor storage techniques. These are highly precise parts, but can also be heavy and bulky to remove by hand. Use of a dedicated work cart exclusively reserved and equipped for extruder head maintenance is recommended. This cart along with a supply of spare components and

hardware is easily justified, especially when examining the potential cost savings that result from well-maintained tools. The following should be considered:

- 1.) Maintain a clean, organized work area with soft and clean renewable work surfaces;
- 2.) Use a vise with soft jaws, such as copper;
- 3.) Use special equipment, such as tip removal tools, etc.;
- 4.) Standard tools include wrenches, soft-faced hammers, etc.;
- 5.) Maintain a supply of soft, clean rags;
- 6.) Use cleaning solutions in spray bottle;
- 7.) Use spare parts as suggested by your tooling supplier, properly organized and stored;
- 8.) Keep handy your equipment's repair/maintenance manual;
- 9.) Have a small surface plate to provide a true flat surface;

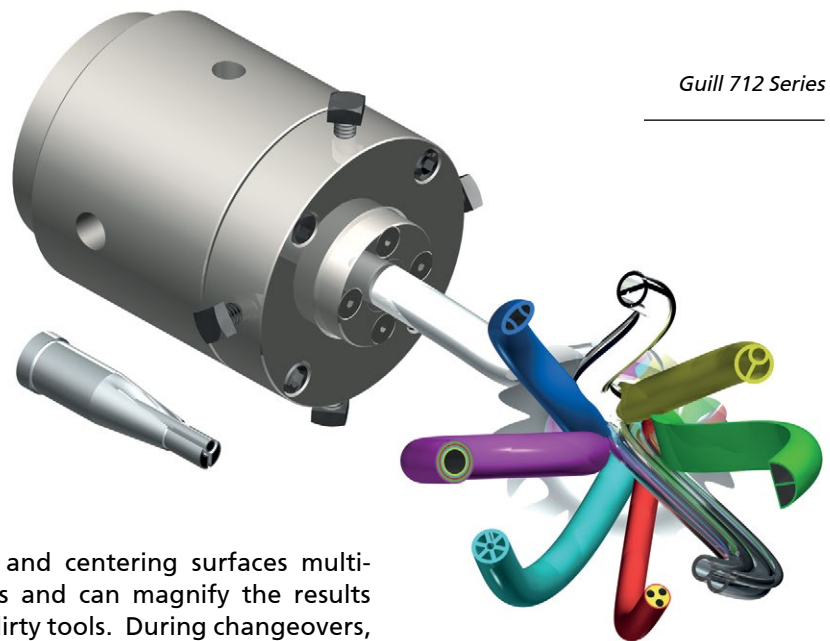

Guill 712 Series

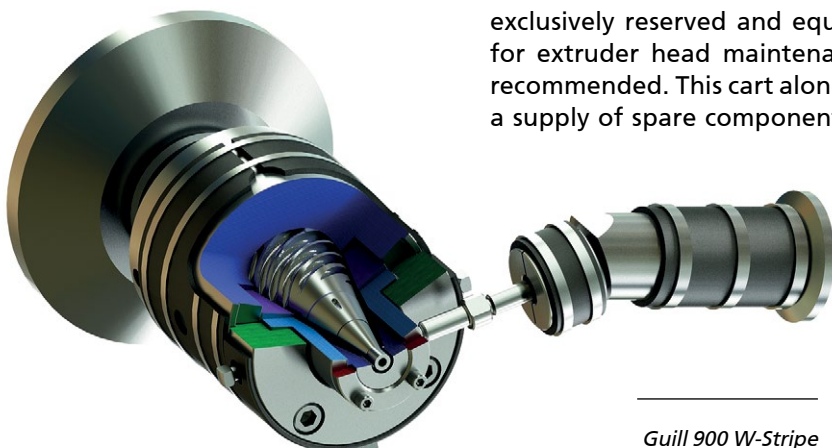

Guill 900 W-Stripe

10.) Use a set of appropriate gauge and tip pins for initial tool location adjustment;

11.) Make sure you have all the proper lifting aids available, including overhead hoists, hydraulic lifts, etc. In most situations, the head and tooling will still be at elevated temperatures, therefore lined gloves are needed when handling. Today, tubing manufacturers compete with companies all over the world. To be a successful and profitable company, quality and efficiency are essential. This is especially true in extrusion, where material costs are usually much higher than labor costs. Like a racing car stuck in the pit, many extruders sit idle because of poor or damaged tooling, plus excess maintenance time. Overhead costs add up and losing money is the result. Some start up quickly and make scrap, whereas others start up and run a product oversized to hold minimum tolerance. They waste 10% to 20% of the material, which can run from 50% to 90% of the product cost. The tooling supplier goes to great lengths so that tips and dies are machined to a determined specification, ensuring perfect concentricity and alignment. The material is then distributed in the proper location as part of the finished product.

Understanding Maintenance Procedures:

Get Organized Before You Start

Example 1: In this example, with an improperly centered tool, a calculated out-of-tolerance area of 0.059 in² (38 mm²) was derived. When the two surface areas were compared, the calculated material waste was 11.8% of the finished product. The formula is % wall = min. wall thickness, max. wall thickness X 100.

Example 2: Alternatively, if the % wall can be increased from 80% to 95%, a savings of about 12% of total cost can result. Savings will vary depending on the designs, of course.

Get help for heavy parts and awkward situations. Surfaces and edges are hard and therefore somewhat brittle, so dropping a part or striking parts together can result in dam-

age. Store your tools properly in a dry, clean area – a dedicated spot for each tool is best. These areas should have soft surfaces and each instrument should be covered after cleaning. Also, tools should be segregated so that they do not come into contact with each other. And tools and all instruments should be cleaned thoroughly before storage.

For disassembly of tools, it is imperative to use purpose-built tooling to facilitate disassembly. These should be available from your supplier. If they are not, consult with a reputable tooling house for replacements. The cost of these tools is easily offset by potential damages, frequently caused by improper equipment such as hammers and drifts. Follow the guidelines outlined in your operator's manual. Individual tools may have specific recommendations, so contact your supplier if anything is unclear. Your supplier understands that optimum performance relies on proper care and maintenance. Here are some useful tips:

1.) Clean your equipment while it is still hot as the residue is easier to remove. It helps to remove and clean one piece of tooling at a time in order to maintain elevated temperatures.

2.) When cleaning a dual compound crosshead, (plastic and rubber) clean the plastic tooling first; the rubber second.

3.) Never use steel tools such as scrapers or screwdrivers because these can scratch and mar the tooling.

4.) Do not use open flames because this generates excessive heat especially in thin sections, which can affect hardness, concentricity and tolerances of components. Recommended cleaning tools and materials include:

a.) Brass pliers to grip material and aid in pulling;

b.) Brass scrapers available in different widths for cleaning flat exposed surfaces;

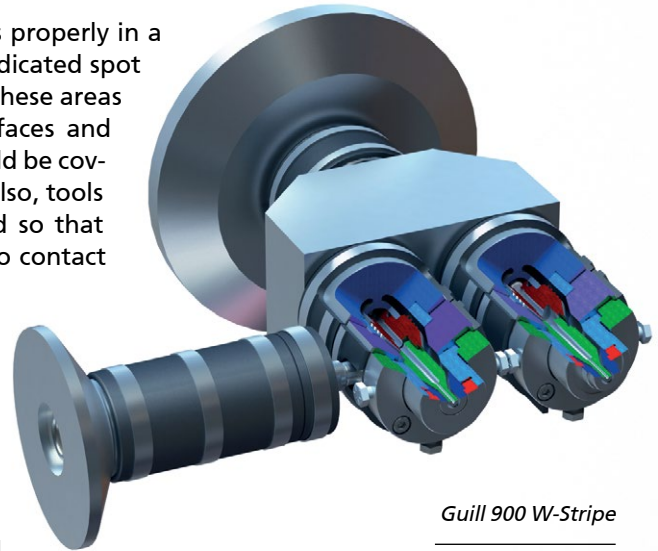

Guill 900 W-Stripe

c.) Brass bristle tube brushes that are available in diameters from 1/16" to 1" in 1/16" increments (ideal for cleaning holes and recesses);

d.) Brass rods – different diameter rods are good for pushing material out of flow holes;

e.) Copper gauze for cleaning and polishing exposed round or conical surfaces;

f.) Copper knives for removing residue from recesses and other hard-to-reach areas. Also, polishing compound restores polished surfaces;

g.) Compressed air, which is more effective for releasing plastic, but also aids in rubber removal. Be careful not to force debris into recesses with compressed air;

h.) Cleaning solutions may be useful, so remember to use fresh, clean rags (used rags often have metal chips embedded in them, which may scratch polished surfaces);

i.) Cleaning oven – for plastic only. Follow manufacturer's recommendations. If no temperatures are specified do not exceed 850 degrees F (454 degrees C). Don't quench tooling to cool, as this could affect tooling hardness, concentricity and tolerances.

j.) Purging compounds – several are offered to purge the extruder screw/barrel of residual polymer and rubber compounds.

Material for Optimum Machining Efficiency

Clean parts are critical to extrusion tooling performance and quality manufacturing. This is es-

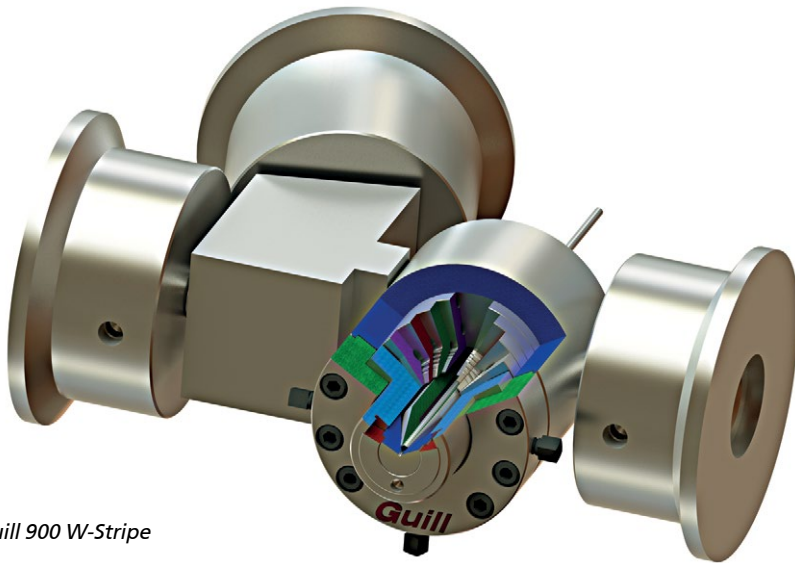

Guill 900 W-Stripe

pecially true for the sealing and locating surfaces – that control uniformity of the production process. For general maintenance of the tools, before storage or tooling changeover, a thorough cleaning and removal of the excess material assures the precision machining alignments required to produce end products to the precise tolerances. Equipment should be cleaned while it is still hot, since residual polymer and rubber will be easier to remove. Be sure to follow all MSDS recommendations when heating the tooling. Thermal gloves are used to protect the hands from the heated tooling surfaces. A brass scraper, as well as a brass or copper wool cleaning cloth are recommended because they are soft enough not to scratch the surface.

Make Tool Cleaning Easier

The quickest way to remove the die is to employ the pressure of the extruder to push it out. Clean the body by using an air compressor and brass pliers so that the material cools down which increases the melt strength, making it into one lump versus an elastic, gummy-like substance that is harder to remove. Cleaning the body feed port using compressed air and brass pliers to simultaneously cool and remove the excess residue from the feed ports. This procedure is followed by brushing with a round brass brush that polishes the surface. The flow area

of the 2" (51 mm) flange adapter should be cleaned by carefully using a brass brush.

Examine all surfaces for any irregularities such as burrs and scratches since these must be repaired before the head is reassembled. Most manufacturers recommend using a hand polishing stone to remove the offending burr. Follow stoning with a light application of 600-grit emery cloth if necessary, but avoid rounding edges that are intended to be sharp. Flat sealing surfaces can also be cleaned using a stone, followed by a 600-grit emery cloth. Place the cloth on a clean, flat surface, preferably a surface plate, then apply friction in a circular hand motion until the area is clean and even. The parts in question should all be hardened steel alloys and will not be adversely affected using these methods. Inconel, monel and Hastalloy® are typically not heat-treated, requiring special care and handling to avoid any damage.

Don't Overlook Repairs

Tooling maintenance helps ensure a quality extruded product – one that meets dimensional specifications, maintains the specified minimum tolerance and is economically produced. Dirty, neglected and improperly adjusted tools contribute to excessive compound applications, which in turn complicate maintenance of minimum thickness tolerance. Excess material results in unnecessary costs and these di-

rectly affect the profitability of your company and the relationships with your customers.

The Important Final Step – Reassembly

Working from your dedicated tool cart, follow the manufacturer's instructions for reassembly. Give each component a final wipe down with a clean rag before installing. Even the smallest amount of grit, dirt and residual material must always be removed. Use mechanical or manual assistance for heavy and awkward components to avoid unnecessary mishaps. Reapply anti seize compound to all fasteners if required. Tighten fasteners to manufacturer's recommended specifications as well as in the recommended sequence. This fastening sequence should be specified in the manual and is generally in a star pattern. Tighten gradually until the proper torque is achieved to prevent distortion of the tooling. One of a die manufacturer's main goals is to form a concentric cone as quickly and accurately as possible in the primary section of the die – when the extrudate first emerges from the die's distribution capillaries. A properly designed and manufactured die has even distribution close to the extrudate entrance point, but this effort is negated once the die is adjusted, shifting the extrudate off to one side. An eccentric cone is formed in the primary area, and a concentric cone exists at only one point in the process, rather than a smooth, continuous flow path with decreasing volume. A properly manufactured and aligned extruded head, along with well-maintained tooling should require little or no adjustment. Another adverse affect of unnecessary die adjustment is the stress introduced to the extrudate caused by unbalanced flow. The net effect is the final product retains memory of this imbalance and unpredictable die swell occurs.

Guill Tool & Engineering Co.,
Inc. 10 Pike Street, West Warwick, RI
02893, USA
www.Guill.com

EXTRUSION

EXPERT MAGAZINE ON PLASTICS EXTRUSION

The only technical magazine worldwide exclusively for the sectors:

- Material Preparation
- Compounding
- Extrusion
- Recycling
- Calendering
- Thermoforming
- Welding
- Finishing of Plastics and Elastomers



Extrusion (German)

Extrusion International (English)

Extrusion International USA (English)

Extrusion Asia Edition (Mandarin/English)

The only plastics trade magazine for Asia, published from Germany

8 issues a year

6 issues a year

6 issues a year

2 issues a year

**SMART
EXTRUSION**

All editions available for free:
www.smart-extrusion.com

VMA Verlag GmbH Cologne/Germany



Regranulation and Plastic Re-Processing

The plastics industry is experiencing continuous growth: valued at US\$593 billion in 2021, it is estimated to exceed US\$810 billion by 2030 (Source: statista). An increase due to both the material's versatility, suitable for multiple applications, and its recyclability, which makes it a valid and environmentally friendly alternative thanks to which rising costs and raw material shortages can be dealt with. In this regard, there is a growing need to reintroduce post-industrial or post-consumer waste back into the production cycle, viewing it as a valuable resource. Thanks to its own know-how, consolidated over more than 75 years of activity, Bausano specializes in finding ad hoc solutions aimed at converting regenerated material into quality products, besides developing dedicated extrusion lines for the recycling of the main polyolefins (HDPE, LDPE and PP) or for the reggranulation of rigid or flexible PVC.

Challenges in plastics recovery

The first challenge in re-processing waste polymers is their degradation, due to the stress suffered by the material, in its virgin state, during initial processing. Specifically, high temperatures and shear forces strongly affect the polymer chain and change its properties. The second challenge, is the risk of wear and damage to the metal components of the plants processing the scrap. In

fact, post-consumer and/or post-industrial thermoplastic material is typically characterized by the presence of impurities, such as glass fibers or metal. The cheapest raw materials are often the most polluted and mixed with other materials, thus the most complex to process. This problem can be addressed, in the first instance, by integrating the best filtration technology into the ex-



trusion plant to purify the plastic from extraneous residues. In addition, Bausano designs and customizes technologically advanced solutions by intervening on individual components. In fact, the special protective coatings applied not only to the screws but also to the collector, granular head and blades of the cutting system, do stand out. Such protective coatings of metal parts are made entirely in-house and designed according to the rheological behavior of polymers in order to ensure their processability and maximum performance in the extrusion process.

Special finishes of metal components

Two finishes that provide excellent wear and corrosion resistance are available: the innovative metallic glass and ceramic-based coat-

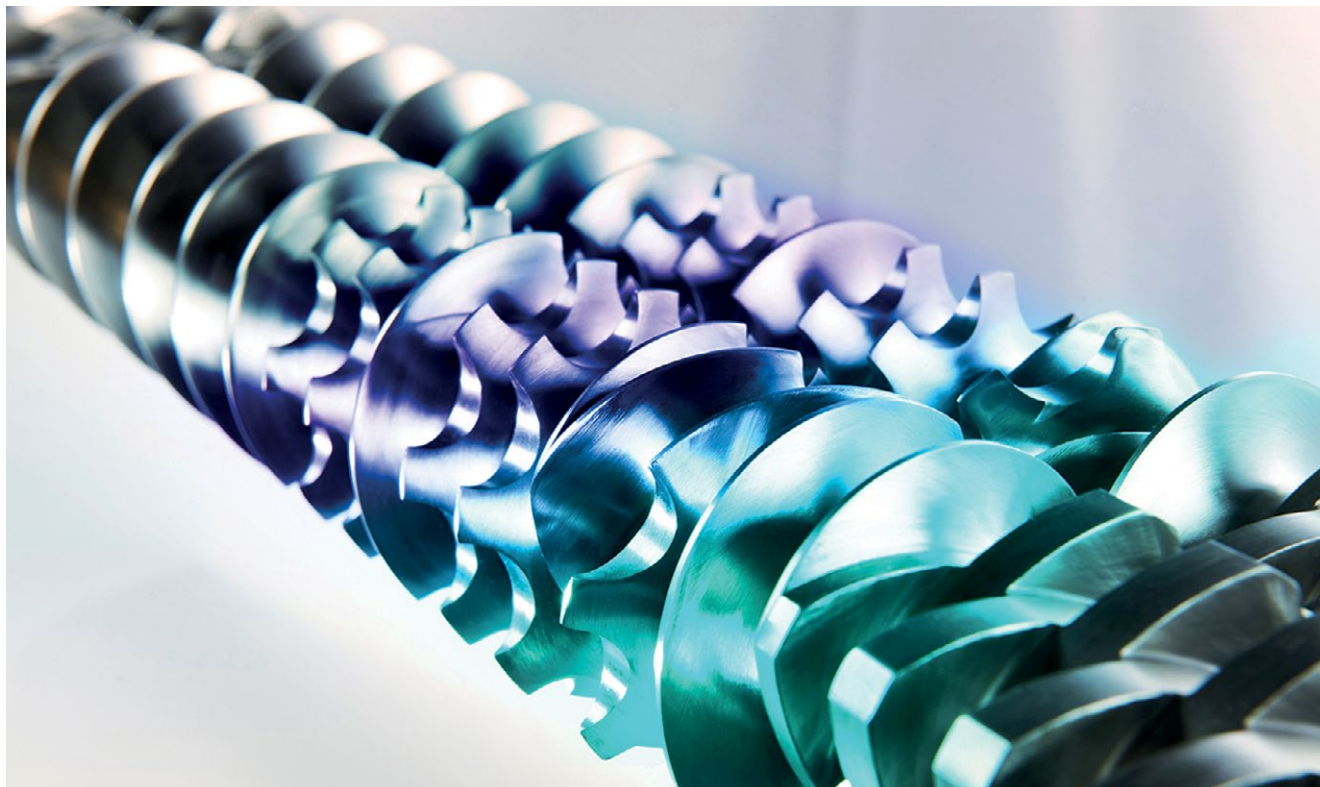

ings. The former, by virtue of its chemical properties promotes melt flow during processing. The second is made through a coating with ceramic properties, which has a low coefficient of friction and is able to cope with aggressive environmental conditions. It is, in fact, ideal for extrusion and molding processes of polymers containing chloride and fluoride. Finally, these coatings, which are applied on screws, extrusion heads in addition to granulation die plates and manifolds, are a guarantee of plant operational continuity over time and of low maintenance costs.

Specially designed components down to the smallest detail

Among the advantages offered by Bausano in the area of designing lines for re-processing scrap material is the study of several variables which affect the processing of raw material: cylinder temperature, screw rotation speed and pressure. First, in order to eliminate stagnation zones that can cause material degradation, Bausano designs screws by taking into analysis the diameter, length, pitch, channel depth and compression ratio. Second, screws should

not have special mixing zones (Notching zones), as this would compromise the quality of the extrudate. Bausano also provides a degassing system, an innovative screen changer with filter meshes with a special geometry to prevent stagnation and with an automatic breaker plate ejection system. Finally, of vital importance is the careful control of the temperature at which gelation is achieved, in the range of 150°C to 170°C depending on the formulation.

E-GO R, revolutionizing polyolefin recycling

Bausano previews the next-generation E-GO R extruder, designed for recycling and repelletizing post-industrial and post-consumer waste, both highly humid and heavy films, with low water content. These include HDPE, LDPE and PP. The contaminated material, after the washing and crushing stage, is conveyed into the extruder by a force-feeding system specifically designed according to the type of use. In the process, moisture and volatiles are removed by means of a single- or dual-zone degassing system. The extruded mass is then filtered and directed to the water or immersion cutting sys-

tem for perfect uniformity of the obtained granule surface.

"In a context in which the regeneration of plastics plays an increasingly central role, making use of specifically designed solutions becomes an essential prerequisite in order to reap the maximum benefits," says Giorgio Critelli, USA Technical Sales Manager at Bausano, who adds "At Bausano, in addition to customizing extrusion lines according to the application and the Customer's needs, we also aim at guaranteeing the highest quality at the technical-performance level, at every single stage of the process, thanks to our in-house design and development department. In fact, we devote special care to selecting the best materials and we intervene on the components that require the most attention with innovative treatments and coatings that make our extruders even more durable and high-performance. An added value that Customers can touch every time they rely on our lines for their plastics processing projects."

► Bausano & Figli Spa
 C.so Indipendenza 111, 10086 Rivarolo
 Canavese (TO), Italy
www.bausano.com

Next Generation of the AllRoundDia DualVision System – *Now for All Colours and for Matt and Glossy Surfaces*

Measuring technology specialist PIXARGUS has enhanced its small-budget system for round products – AllRoundDia DualVision – with a major upgrade. This two-in-one inspection system, designed to measure both the entire surfaces and contours of hoses, tubes and cables continuously and through 360°, has been fitted with a newly developed light ring and a new lighting concept. With these new advanced features, the system is now also able to measure and inspect glossy round products and translucent, semi-transparent hoses.

The new-generation system comes in a slightly different look – for a good reason: Instead of the open light ring that gave the earlier system its typical omega shape, it now has a completely enclosed illumination field. Some of the interior components have also been



The next-generation AllRoundDia DualVision system from PIXARGUS features a closed illumination field. This provides more homogeneous lighting and, as a result, an even better light yield than before. Therefore, surface inspection of glossy round products or translucent and semi-transparent hoses is no longer a problem



modified: The LED arrays in the measuring head, for example, have been fitted with new diffuser material to optimize light diffusion.

New lighting concept

The system uses a new, fundamentally modified lighting concept. "With the new concept, we achieve a very homogeneous illumination of the measuring field and a significantly better light yield," explains the project engineer responsible at PIXARGUS for the technological upgrade of the system. The roughness parameters that determine the contrast and level of detail for the sen-

The upgraded version of AllRoundDia DualVision is validated for analysis of an extended range of products. The systems are supplied ex works with data preconfigured for numerous products and materials. The data can be called up via the product selection menu on the display

If the system requires recalibration, the operator can perform this with minimum effort via the software program using the auto-calibration kit that PIXARGUS has developed specifically for the AllRoundDia DualVision systems. Thus, the customers no longer depend on fixed calibration intervals that may interfere with the production process



sors can be adjusted much more finely. "The system's settings can be made with a sensitivity of 99.9%, no matter whether we are inspecting white, yellow, green, red, transparent, matt or glossy surfaces." The optimized inspection and measuring software eliminates all interfering reflections.

Combined or separate use of surface inspection and dimension measurement

The underlying measuring technology has also been upgraded. While the previous systems could only perform dimension measurement and surface inspection in parallel, the upgraded system provides the option to switch the geometry measuring module on and off, as desired.

Display of defects magnified with a swipe

A further enhancement of the new AllRoundDia Dual-Vision generation is its more comfortable integrated HMI. While the HMI of the earlier systems were only able to show the dimensional and surface-related information next to each other on the 10-inch screen, it is now also possible to display the information separately. The operator can call up specific views, such as certain surface areas, with simple navigation gestures. Thus, defect images can be magnified on the display virtually with a swipe of your finger.

Validated for a wide product range - for more plug and play capability

By analyzing existing reference samples and previous customer specimens, in particular specimens with glossy surfaces, PIXARGUS has put the new AllRoundDia Dual-Vision generation on a well validated basis for a very wide range of products.

With obvious success: "When we receive a request from a customer now, all we need to do is perform a quick sample check. In more than 90% of the cases, we can sell the system 'off the shelf'," says PIXARGUS Sales Manager Michael Frohn. For a wide range of materials, the product data are preconfigured ex works. Hence, commissioning at the customer's site takes just one day as a rule. The PIXARGUS team is very happy about this result: "With our upgraded system, we have created a new standard for plug and play." Several commissionings at our customers' sites have shown that it works.



Dimension and surface information can now also be called up separately. It is possible, for example, to select views of certain surface areas and magnify defect images virtually with a swipe of your finger

PIXARGUS GmbH
 Industriepark Aachener Kreuz,
 Monnetstr. 2, 52146 Würselen, Germany
www.pixargus.com

Asian representation:
Melchers Ltd.
info@sh.melchers.com.cn
www.melchers-techexp.com

Automated Color Control for Recycling

The required high recycling rates for plastics are a significant challenge for recyclers of plastics for a variety of reasons. A high and verifiable quality must be achieved both in sorting and in the further processing steps. For the separation of the plastic types, there are already many technical solutions or approaches with corresponding potential for improvement for the sorting results. Color sorting, on the other hand, is usually very time-consuming and cost-intensive if high sorting qualities are to be achieved.

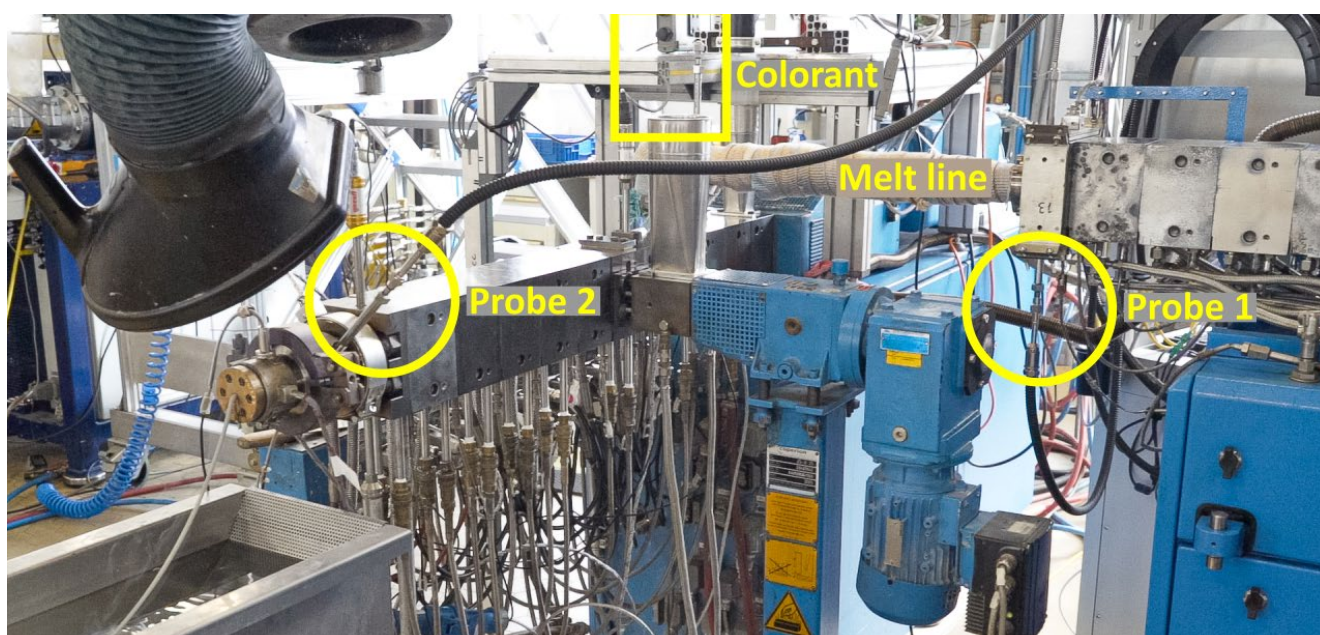

Authors:

SKZ Würzburg: Franziska Eichhorn,
Julia Klein, Dr. Linda Mittelberg
ColVisTec AG: Fuat Eker

When processing plastic waste that has not been sorted by color, no reliable prediction can be made about the color after processing, since the color composition of the recycled material varies from batch to batch as well as regionally and seasonally (Figure 2). Currently a significant excess of colorant is used in the coloring process to achieve the desired target color in order to obtain a homogeneous colored regranulate. In a joint research project, SKZ – the South German Plastic Center, Würzburg, and ColVisTec AG, Berlin, have addressed this problem and developed a system for safe and material-efficient coloring

during the processing of unmixed, unsorted recycled material. This system makes it possible to build up a control system that adjusts the addition of the colorant during coloring based on the input material and thus enables a constant product color with fluctuating input material.

Description of the experimental setup and the measuring equipment used

For the realization of a control loop in the coloring of recycled plastics, a cascade was set up on the basis of two twin-screw extruders, simulating a recycling plant on a small scale. For this purpose, both extruders were coupled to each other via a melt line. The first extruder is used to melt the material, while the second extruder is used to color the material. At the end of each extrud-

Figure 1: Cascade setup in the SKZ pilot plant in Würzburg, consisting of two twin-screw extruders with two probes connected in parallel with InSpectro X2 from ColVisTec

er, a measuring point for color measurement was implemented via the InSpectro X2 inline spectrometer (see Figures 1 and 3 for a schematic diagram of the cascade).

The InSpectro X2 from ColVisTec is a high-resolution UV-Vis inline spectrophotometer with the special feature of operating two probes in parallel and thus displaying both measurement results on one screen for process monitoring. It is designed for 24/7 use in production environments with dust, splash water, temperature changes, vibrations, etc. The probes used are specially developed for the application

in extruders and are suitable for melt temperatures up to 400 °C and 250 bar process pressure.

Variations of the input material and basic investigations

For the development of the control loop, material systems of different batches of not pre-sorted PP regrind in terms of color were used (light and dark blends), which were colored with masterbatch. The InSpectro X2 was used to determine the residence time in the extruder by adding a tracer at a precise time. This made it possible to determine the time intervals between the individual measuring points at the end of the respective extruder and the corresponding metering of the masterbatch. This enables defined metering of the color addition in a control loop.

In order to be able to assess the color variations of the materials used, these were run on the cascade and the color determined inline with the InSpectro X2. The evaluation of the data shows that the respective batches exhibit random fluctuations on all three axes of the L*a*b* color space. The fluctuations at the end of the first extrusion (measuring point 1) are still considerably higher than at the second measuring point

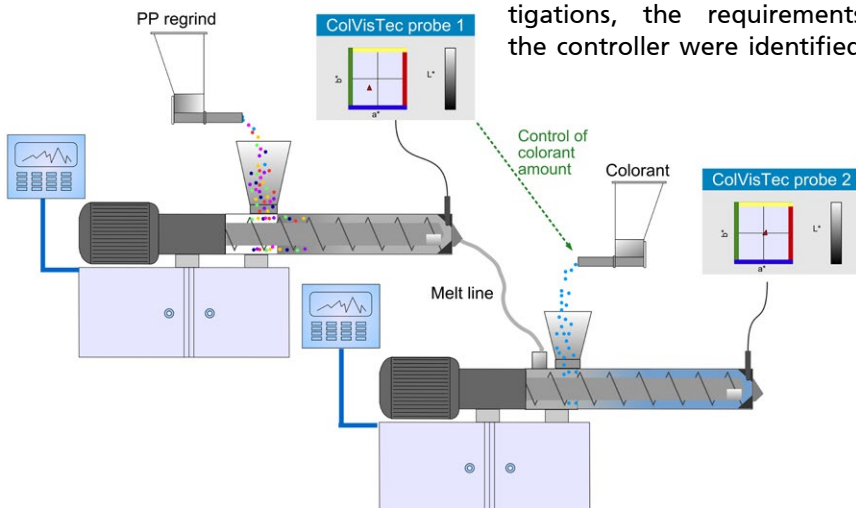

Figure 2: Blend of PP flakes (PCR)

at the end of the second extruder. This can be attributed to the double extrusion and improved homogenization. In the industry, only very small total color deviations of $dE^* < 1$ are tolerated. The measured color variations both within the base material and the difference between the individual batches exceed this total color distance of the industry and must, therefore, be compensated for during coloring. The initial focus of the investigations was on the L* axis (lightness). For this purpose, recycled flakes were dyed experimentally with different concentrations of black or white masterbatch. During coloring, it was generally found, as expected, that with an increasing amount of masterbatch, the color runs into saturation. At the same time, the fluctuations in the L*a*b* color space decrease.

determination of residence time). Software was developed to control automated coloring by means of two probes and a dosing system with color masterbatch. The basis is the input of a setpoint value of the color axis to be controlled. By means of the detected color fluctuation at measuring point 1, the dosing of the color of the second extruder is regulated so, that a constant color is obtained at the second measuring point. Here, the software adjusts the addition of the colorant based on the detected color values. Control by means of the first measuring point is particularly important in the case of large color fluctuations within a batch and during batch changes, since control interventions here lead to a more stable product. Smaller fluctuations in color can be adjusted with the measured value from the second measuring point, since the higher mixing effect from the second extruder enables more precise control. Consequently, both measuring points have an important role in the control loop and, especially in the combined application, form an ideal basis for the control towards a stable product.

Figure 3: Schematic diagram of the cascade setup consisting of two twin-screw extruders with two probes connected in parallel with InSpectro X2 from ColVisTec and the automated color control system



Implementation of the controller

Based on the preliminary investigations, the requirements for the controller were identified (e.g.

Dyeing with closed-loop control

In the following example, PP regrind is used in light and dark blends. These blends vary within their respective batches and the difference between the two PP blends is about 12 units in L* (lightness). A

Input: variable PP flakes
Extruder 1

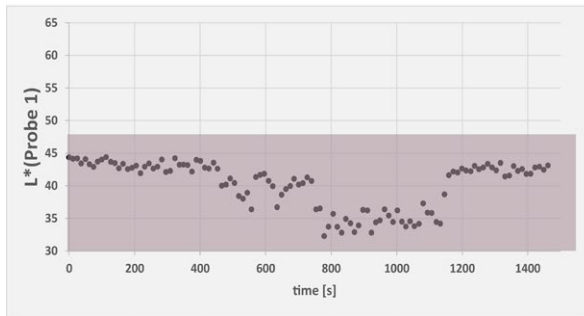

Output: Steady PP strand at target $L^* = 62$
Extruder 2

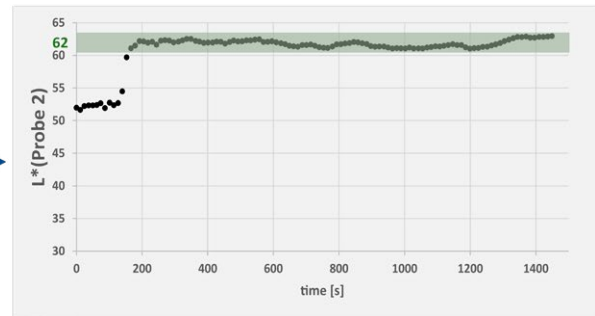

Figure 4: Used material light and dark PP flake blends (extruder 1), color control to a predefined color value, here $L^* = 62$ (extruder 2). At a time of 700 s, a batch change was performed between two similar batches (compare measurements on extruder 1 with probe 1 on the left), which had no effect on the desired brightness of the material (compare measurements on extruder 2 with probe 2 on the right)

target value of 62 for L^* is set for the trial. The control system must maintain this brightness value regardless of the starting material used and, for this purpose, vary the addition of masterbatch accordingly. For the execution, extruder 1 is fed with the light PP compound at the beginning, directly afterwards with the dark PP compound (after approx. 700 s) and then switched back to the light PP compound (after approx. 1200 s). Large fluctuations in L^* can be observed both within the individual batches and during the batch changes (Figure 4 left). These small as well as large fluctuations in lightness are automatically compensated for by the color control system over the entire process duration by variable colorant addition to a constant $L^* = 62$ (Fig. 4 right). To complete the proof of automatic con-

control, a constant result was achieved on one color axis in a further experiment, also with fluctuating starting material.

This was shown by the example of the b^* value, where the input material varied from +1 to +6 (yellow) for b^* and a control was set to a constant b^* value of -3 (blue) (Figure 5).

Conclusion

Color control in plastics processing is still mainly empirical. The implemented concept of inline measurement of the color at two points in the process in real time allows reliable control of the color to a defined value of one of the axes of the color space. The concept can also be transferred to three-dimensional color control, although here several metering and measurement control loops are necessary to map

the three-dimensional color control. The necessary developments are being pursued on the basis of the results shown. In addition, the experimental data also indicate that it may be possible to reduce the complexity of the setup to just one measuring point. Interested companies are invited to become acquainted with the possibilities of the new system, also within the framework of cost-neutral trials at the SKZ.

This project was funded by the German Federal Ministry of Economics and Climate Policy (BMWK) based on a resolution of the German Bundestag. SKZ - the South German Plastics Center and ColVisTec AG would like to thank the German Bundestag and the BMWK for the financial support.

ColVisTec AG

Max-Planck-Str. 3, 12489 Berlin, Germany
www.Colvistec.de

SKZ – Das Kunststoffzentrum
Würzburg, Germany
www.skz.de

Figure 5: Varying b^* value between +1 and +6 (yellow) detected in extruder 1 with probe 1 and a constant target b^* value of -3 (blue) detected in extruder 2 with probe 2

Input: variable PP flakes
Extruder 1

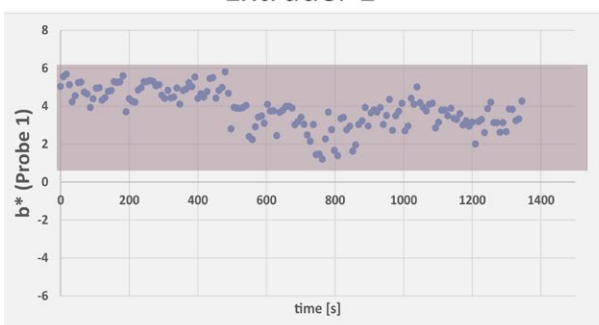

Output: Steady PP strand at target $b^* = -3$
Extruder 2

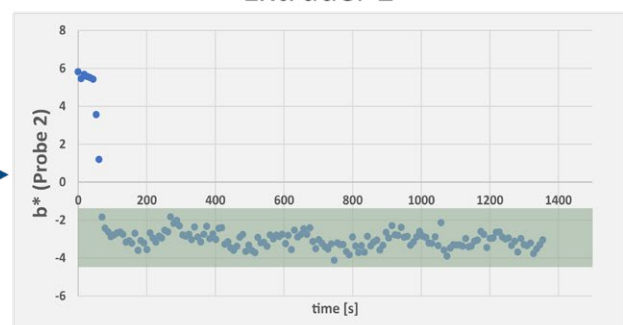

SMART EXTRUSION

**THE SPECIALIZED WEBPORTAL
ON EXTRUSION
FOR EVERY MODERN NEED**



VM Verlag GmbH
Cologne, Germany



www.smart-extrusion.com

Larger Pressure Gradient – Smaller Cells

Optimisation of the Foam Structure with Adapted Die Design

Author:

Ch. Hopmann, M. Stieglitz

The constantly increasing economic competition as well as the demand for a good life cycle assessment of packaging materials is confronting film producers with ever greater challenges [ESE20]. Due to the introduction of regulations in the packaging sector, material consumption is increasingly coming into focus. At the same time, the reduction in material consumption leads to a reduction in material costs, which account up to 80% of film production costs [HHH14].

The further development of technical processes offers the possibility to reduce the material input and thus has great potential to increase the economic efficiency of blown film extrusion. The saving of plastics can be realised by foaming, which reduces the density. In this way, material costs and the amount of raw materials can be optimised [Sta06]. Foamed plastics are also characterised by improved properties in certain areas. For example, foaming increases the thermal insulating effect [Tol15].

The combination of plastic foaming with blown film extrusion offers a highly efficient production process for manufacturing novel film products (see Fig. 1). Foaming in the middle layer of multilayer blown films offers several advantages as the layer structure. Due to the compact outer layer, all possibilities remain open about appearance, printability, haptics and possible laminating or sealing functions. Foamed packaging is used, for example, to protect sensitive foodstuffs such as fruit, so that damage and thus premature spoilage is prevented. Because of the good thermal insulation of the foams, they are also used for packaging fast food in order to keep the temperature change of the food as low as possible [URL21].

The layer thickness ratio is largely responsible for the property profile of the foamed multilayer blown film. The foam structure should not be visible on the surface and considerable material savings must be aimed for. The resulting cavities also influence the mechanical properties of the film, which depend on the foam structure. For this reason, the objective in foam extrusion is to achieve a structure, that is as fine-cell as possible, since this results in higher mechanical properties of the film compared to a large-cell structure.

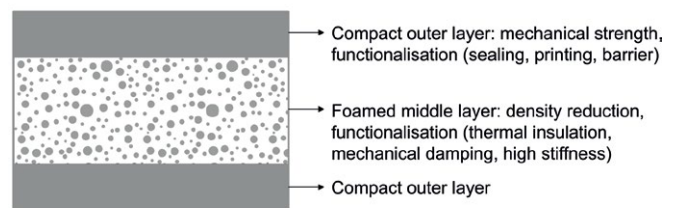

Fig. 1: Multilayer film with foamed middle layer

The foam structure depends on material parameters such as extensional viscosity and process parameters such as temperature or pressure, and also on the die technology. The process understanding of foam extrusion is not yet sufficiently, so that further investigations and developments are needed. In the further section, the optimisation of the die technology will be discussed, which can be varied to achieve a fine-cell foam structure for blown films. In this context, the influence of the die design is of particular importance.

Research on the development of a new die design for improved foam structure

In order to avoid high degrees of stretching, which lead to thinning of the film and stretching of the foam cells and to further optimise the foam structure, it is necessary to investigate the influence of different die geometries in more detail. Achieving a fine-cell foam structure is important to achieve maximum density reduction while maintaining good mechanical film properties. The objective is therefore the development of a

Fig. 2: Schematic layout of the three design parameters of the die and CAD model of the die insert

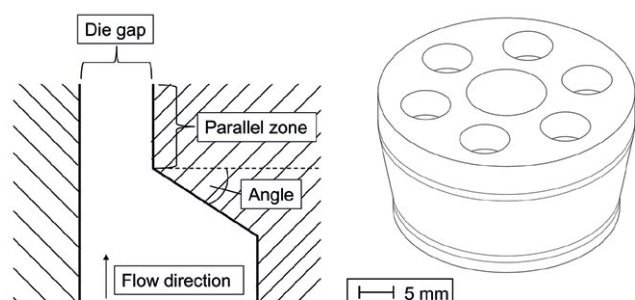

Die geometry				Pressure loss: Δp [bar]
Die number	Die gap: D_g [mm]	Parallel zone length: L_{Pa} [mm]	Angle: \angle [°]	
D1	0.3	0.0	70	34.4
D2	0.4	7.5	2 steps: 80 at $z = 0-25$ mm 76 at $z = 33-41$ mm	36.4
D3	0.5	3.4	45	42.4
D4	0.5	0.0	80	38.3
D5	0.7	4.0	80	47.8

Table 1: Analytical calculation of pressure loss at $m_{ges} = 15$ kg/h

novel die design. The influence of the different die areas and the die gap is used to adapt the foam structure in a systematic way.

Design and analytical investigations of different blown film dies

In the first step, the standard die design, which was not optimised for foaming, was examined in detail and considerations were made, how the die design should be varied. The outlet of an extrusion die for blown film extrusion consists in most cases of a reduction of the diameter at a certain angle, a parallel zone as well as the outlet gap. These three design parameters, shown in Fig. 2, influence the behaviour of the plastic melt in the

extrusion die. The parallel zone length L_{Pa} designates the section in the die gap where there is no longer any reduction in the diameter. Thus, the die gap is constant over the parallel zone length. The die gap D_g corresponds to the thickness of the unfoamed film tube exiting the die. The angle \angle determines how fast the diameter changes to the final die gap.

Based on the three design parameters angle, parallel zone length and die gap, a re-design of the die was made and then also analytically calculated. For the analytical calculations, the die is considered as an annular gap and further simplifications are made according to [HM16]. The outer die diameter of the blow head is 80 mm and was kept constant as well as the mass throughput of 15 kg/h. The calculations are based on the material parameters of PE-LD. Fig. 3 shows the die curves of all five dies. These differ from each other by the length of the parallel zone, the width of the outlet and the angle. In the process, care was taken to ensure that there was a large variance in the individual zones.

The differences between the re-designed dies in the three areas of outlet gap, parallel zone and angle are shown in Table 1.

In previous extrusion test with the reference die (D5) the extruder of the middle layer with a diameter of 35 mm (compared to the outer extruder $D = 45$ mm) reached its pressure limit of 300 bar at higher mass throughputs. To avoid this, the total pressure was reduced, especially for the small outlet gaps. Since the pressure gradient is also crucial for achieving a fine foam structure and a high nucleation rate, special attention was given to this parameter in the design, taking into it the knowledge gained previously. The total pressure loss of the individual dies is also shown in Table 1.

In the following, the results of the analytical calculations in Fig. 4 for the die with the 0.3 mm (D1) and in Fig. 5 for the die with the 0.7 mm (D5) outlet gaps are presented as examples. If the diagrams for the 0.3 mm gap are compared with those for the 0.7 mm gap, it can be seen, that with the die D1 the pressure loss occurs in a significantly shorter range and in a shorter time. The analytical calculations show, that with die D5 even a larger pressure loss results. However, this is built up over a longer period of time. For the production of foamed blown films, it is expected that especially the novel dies (D1, D5) are characterised by a good foam structure, since the pressure loss with these dies occurs particularly quickly and over a short die length.

Fig. 3: Gap shape of the re-designed dies

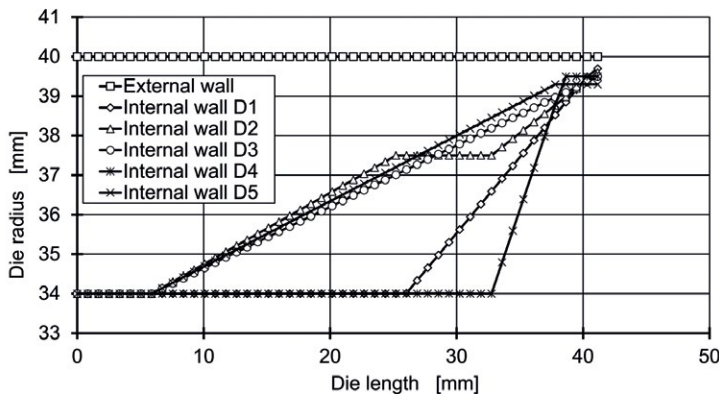
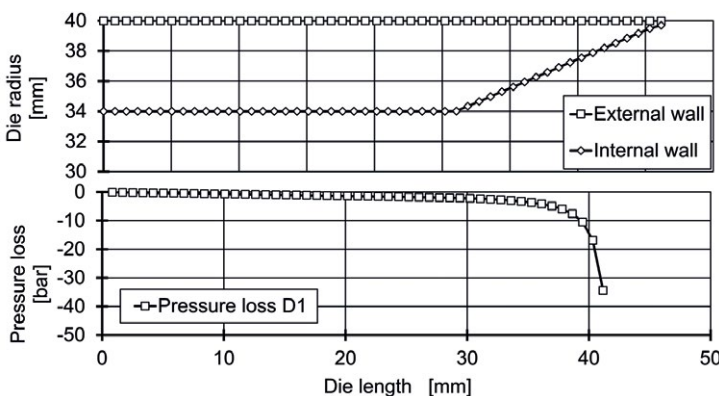

Fig. 4: Influence of die design D1 ($D_g = 0.3$ mm, $L_{Pa} = 0$ mm, $\angle = 70$) on pressure loss



Extrusion tests with different die designs

For the validation of the analytical investigation and to evaluate the process capability of the dies, extrusion tests were performed. The influence of the die design on the foam structure was carried out in a chemical foaming process. For this purpose, different proportions (3-15 %) of a chemi-

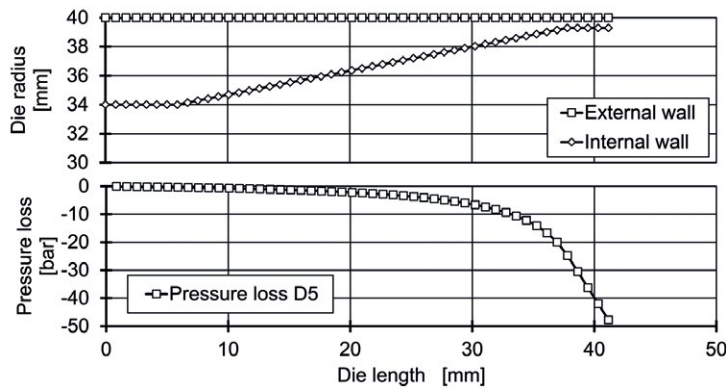

Fig. 5: Influence of die design D5 ($D_g = 0.7$ mm, $L_{pa} = 4$ mm, $\angle = 80^\circ$) on pressure loss

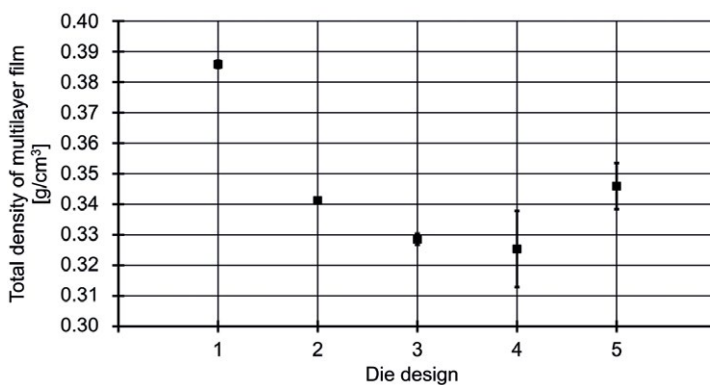

Fig. 6: Influence of die design on the total density of the multilayer film

cal foaming agent (CFA) Hydrocerol from Avient, Avion Lake, Ohio, USA, were added to the plastic granulate in preliminary tests and the degree of foaming was investigated. Hydrocerol is a chemical foaming and nucleating agent, which is particularly suitable for the production of fine-cell foams. A chemical foaming agent improves the plasticisation of the plastic, which reduces the required heat input. This can save energy and improves the CO_2 balance of the process. The highest degree of foaming with a good foam structure was achieved with 7 wt.-% Hydrocerol and kept constant in the further tests.

For the production of a three-layer film, with compact outer layers and foamed middle layer, a three-layer blown film line from Kuhne Anlagenbau GmbH, St. Augustin, Germany, is used for these tests. The melt is distributed in an annular gap by a radial spiral distributor and exits through the re-designed and manufactured dies. To evaluate the influence of the die-dependent foaming behaviour during film production of the die design, the plastic material is kept constant for all film layers as well as for all tests. A low-density polyethylene 2102X0 from Sabic Europe, Geleen, Netherlands, was used. The MFI (190°C, 2.16 kg) of the material is

1.9g/10min [NN21], which on the one hand reduces the foaming of the middle layer due to the high viscosity of the outer layers, as the added foaming agent reduces the viscosity of the middle layer. On the other hand, a long foam growth of the middle layer is avoided compared to a material with lower viscosity.

In order not to have to estimate the pressure loss at the die via the extruder pressure of the middle layer, a new die housing was designed and manufactured which enables the measurement of the melt pressure and the melt temperature approx. 60 mm before the melt exits.

Blown films were produced for the following analyses of the foam structures. The parameters of the test series are summarised in Table 2. For each die geometry, the mass flow rates are varied on two levels (8/11 kg/h), as they also have an influence on the pressure gradient and thus affect the cell size. For the individual process points, the parameters were kept constant, with the blow-up and take-up ratios playing a particularly important role. This ensured that films with a thickness of 125 μ m were produced. The mass flow rate ratio of the two outer layers to the middle layer is two. The two outer layers were operated with the same mass flow rate of 1.

With the 10 test points, the influence of the die design on the process stability could be evaluated well. The process ran trouble-free with the reference geometry with an outlet gap of 0.7 mm (D5) as well as the two new dies with 0.5 mm (D3, D4). At the different process points, a three-layer structure with a foamed middle layer could be produced. The die D4 showed good production behaviour and better process stability compared to the die with the same outlet gap but different parallel zone and angle (D3). The dies with an outlet of 0.3 mm (D1) and 0.4 mm (D2) showed an increased number of film tears and it was not possible to set up a stationary process. However, film samples were still taken in order to be able to evaluate the foam structure afterwards. The very small gap meant that the expanding cells disrupted the very thin film in many places and thus no stability could be brought into the film tube.

Influence of the die design on the foam structure

The foam structure of foamed blown films is, next to the process stability during extrusion, the most important factor for the evaluation of the novel die designs. A fine-cell, homogeneous foam structure was aimed for. The two most important parameters for assessing foam quality are the density of the blown film and the cell size.

With the help of the density, the material savings can be evaluated. However, the density of the film does not allow direct conclusions to be drawn about the cell size

Table 2: Process parameters used in the extrusion trials

Material	Hydrocerol-percentage [wt.-%]	Mass-throughput [kg/h]	Mass-throughput ratio [-]	Temperature [°C]	Film thickness [μ m]	Blow-up-ratio [-]
PE-LD 2102X0	7	8/11	1:2:1	All zones 170	125	2

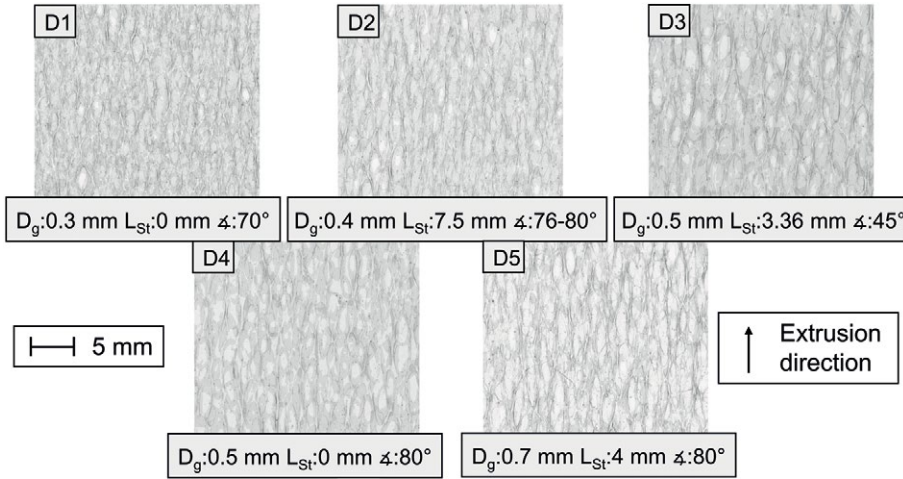

Fig. 7: Images of the foam structure of the different die designs with a bi-telecentric lens

For the investigation of the cell size, a film sample was taken from each sample. For optical analysis images were taken with a camera COE-050-M-POE-050-IIR-C and the corresponding bi-telecentric lens TC23036 from Opto Engineering, Mantova, Italy. The foam structures were then evaluated in two dimensions. For this purpose, lines were placed in the cells and the number of pixels along them was counted. The number of pixels is converted into a metric length by scaling. For the calculation of the cell area C_{area} the cell is approximated as an ellipse (Eq. 4.1). For each image, the cells were measured along the length and horizontally to the direction of the pull-off. C_a stands for the cell dimension along the pull-off direction and C_{trans} for the cell dimension transverse to the pull-off direction.

or the volume of a single cell. To determine the total density of the three film layers, a circular sample of the film is taken. The thickness of the film is measured at 12 points equidistantly distributed on the radius. The film thickness is used to calculate the volume of the film. In addition, the weight of the sample is determined. With the presence of the two described quantities, the density of the total film can be determined (see Fig. 6). Since the process points were kept constant for all the dies, the density of the total film can be compared directly with each other. It should only be noted that this is not the density of the foamed middle layer.

$$C_{area} = C_a \times C_{trans} \times \pi/4$$

The total density of the multilayer film varies between 0.325 g/cm³ and 0.386 g/cm³ for all dies, so that the densities differ relatively little from each other. The highest value (0.386 g/cm³) determined occurs with the die D1 and the two lowest values of about 0,325 and 0.328 g/cm³ were achieved by the dies with an outlet gap of 0.5mm (D3, D4).

A comparison of the images of the foam structure (see Fig. 7) with the cell sizes determined in Fig. 8 illustrates, that the dies with the lowest outlet diameters (D1, D2) lead to the smallest cell size. The images are characterised by a very fine and homogeneous foam structure. This was to be expected, as the pressure gradient in the die gap increases with a smaller die gap. The dies D3 and D4, which produced the lowest film density achieve an average cell size. However, the D4 with no parallel zone is about 0.4 mm² below the other die. The reference die (D5) achieves the worst foam structure with the highest cell size on the images compared to the other structures. The relatively low standard deviation (see Fig 8) of all foam structures indicates a very homogeneous distribution of cell sizes.

Since a low density can also be achieved with large cells, the next step is to examine the cell size.

Due to the poor process stability of the dies (D1, D2), both flow channel designs are not suitable for further use in the production of blown film. Because the die (D4) is characterised by the smallest cell size (1.84 mm²), suitable process stability and the lowest overall density (0.33 g/cm³) compared to the other dies, it was selected as the final die.

Fig. 8: Influence of die design on the cell size

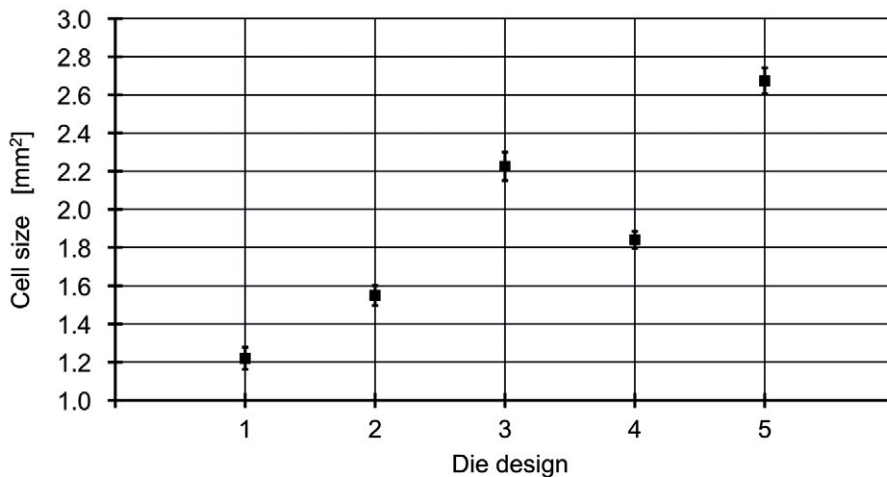

Conclusion and outlook

For the development of a novel die design for foamed multilayer films, the influences of the three design parameters die gap, parallel zone length and angle were determined. After the construction of five die designs, the influence on the pressure loss

was shown by further analytical investigations. In the subsequent extrusion tests, problems occurred in the process stability, so that the dies with a small exit gap were not suitable here. In order to evaluate the foam structure, an optical measuring method was presented with which the cell size could be determined. With the finally selected extrusion die, blown films with a fine-cell foam structure could be produced and a stable process could be guaranteed. Furthermore, this die with a smaller outlet cross-section of about 0.5 mm is suitable for the production of thin films with a lower degree of stretching.

After the analysis and selection of the extrusion die, the further development of the extrusion technology should be followed by a focus on the influences on the material side. The molecular structure (molecular weight, molecular distribution, degree of branching) and the rheological properties (elongational viscosity) of the plastic have an influence on foam formation [Kro98, Sta06]. Therefore, a precise characterisation should be carried out to know especially the elongational viscosity of the plastics used. The determination of the elongation strength, which correlates with the elongation viscosity, can be done with the help of a membrane inflation rheometer.

Further developments in the field of foam extrusion are needed, as the application of foamed multi-layer packaging films will continue to expand thanks to the excellent thermal insulating effect in combination with the economic and environmentally friendly advantages of material reduction.

Acknowledgment

The research project (18977 N) of the Forschungsvereinigung Kunststoffverarbeitung is sponsored as part of the "industrielle Gemeinschaftsforschung und -entwicklung (IGF)" by the German Bundesministerium für Wirtschaft und Energie (BMWi) due to an enactment of the German Bundestag through the AiF. We would like to extend our thanks to all organisations mentioned. In addition, the authors would also like to thank the companies Sabic Europe, Geleen, Netherlands and Clariant AG, Muttenz, Switzerland for providing the test materials.

► Institute for Plastics Processing
at RWTH Aachen University (IKV)

Seffenter Weg 201, 52074 Aachen, Germany

Marius Stieglitz, M.Sc.,

marius.stieglitz@ikv.rwth-aachen.de, www.ikv-aachen.de

References

- [HHH14] Hopmann, Ch.; Hennes, J.; Hennigs, M.; Hendriks, S.: Effizienzsteigerung in der Folienextrusion. Integrative Kunststofftechnik 2014 (Tagungsband). Aachen: Shaker Verlag, 2014
- [Kob12] Kobmiller, C.: Langfristiges Denken zahlt sich aus. *Plastverarbeiter* 63 (2012) 1, pp. 16-18
- [Sta06] Stange, J.: Einfluss rheologischer Eigenschaften auf das Schäumverhalten von Polypropylenen unterschiedlicher molekularer Struktur. Universität Erlangen-Nürnberg, Dissertation, 2006
- [Tol15] Tolinski, M.: Additives for Polyolefins (2nd Edition). Amsterdam: Elsevier Science, 2015
- [MH10] Michaeli, W.; Hildbrand T.: Schaumextrusion mit OptiFoam – Potenziale physikalischer Treibmittel. *Blasformen & Extrusionswerkzeuge* 4 (2010), pp. 5-10
- [Dau08] Dauch, M.: IKV-Fachtagung „Kunststoffschäume - Neues aus Spritzgießen und Extrusion“ Chemische Treibmittel - Eine Einführung in das Schäumen von Polymeren, 2008
- [Weg05] Wegner, J.-E.: Additiv-Masterbatches für Schaumfolien. *Kunststoffe* 95 (2005) 1, pp. 86-90
- [Zha10] Zhang, H.: Scale-Up of Extrusion Foaming Process for Manufacture of Polystyrene Foams Using Carbon Dioxide. Universität Toronto, Canada, Dissertation, 2010
- [Gla17] Gladbach, P.: Herstellung von Schaumfolien aus Polystyrol mit Treibmittelgemischen. Institut für Kunststoffverarbeitung, RWTH Aachen, unveröffentlichte Bachelorarbeit, 2017 - Betreuer: R. Breuer
- [Kos96] Koschmieder, M.: Untersuchung verschiedener Einflussgrößen bei der Schaumextrusion von Polyethylen mit als Treibmittel. Institut für Kunststoffverarbeitung, RWTH Aachen, unveröffentlichte Diplomarbeit, 1996 – Betreuer: D. Kropp
- [Lan95] Landrock, A. H.: Handbook of plastic foams: types, properties, manufacture and applications: Noyes Publications, 1995
- [Hop18] Hopmann, Ch.: Entwicklung eines Herstellverfahrens für physikalisch geschäumte Mehrschichtblasfolien. Institut für Kunststoffverarbeitung (IKV) in Industrie und Handwerk an der RWTH Aachen, Abschlussbericht zum IGF-Vorhaben Nr. 18977N, 2018
- [HM16] Hopmann, Ch.; Michaeli, W.: Extrusion Dies for Plastics and Rubber - Design and Engineering Computations (4th Edition). Munich: Carl Hanser Verlag, 2016
- [Hei02] HEINZ, R.: Prozessoptimierung bei der Extrusion thermoplastischer Schäume mit als Treibmittel. RWTH Aachen, Dissertation, 2002 – ISBN: 978-3-89653-995-3
- [NN12] N.N.: Produktion, Verarbeitung und Verwertung von Kunststoffen in Deutschland 2011. Firmenschrift, Consultic Marketing und Industrieberatung GmbH, Alzenau 2012
- [NN21] N.N.: SABIC® LDPE 2102XO. Datenblatt, Sabic AG, Europa, 2021
- [Kro98] Kropp, D.: Extrusion thermoplastischer Schäumen mit alternativen Treibmitteln. RWTH Aachen, Dissertation, 1999 - ISBN
- [URL21] N.N.: Was sind Schaumstoffe? URL: <https://verpackungen.de/info/was-sind-schaumstoffe>, accessed: 18.09.2021
- [ESE20] Eyerer, P.; Schüle, H.; Elsner, P.: Polymer Engineering 3. Werkstoff- und Bauteilprüfung - Recycling - Entwicklung. Berlin: Springer Verlag, 2020

How to Provide Pure Raw Material for Perfect Films in Food Packaging

Industrie Polieco-MPB uses SIKORA's PURITY SCANNER ADVANCED to ensure highest material purity for their adhesives. The Italian-based Industrie Polieco-MPB group is the biggest European compounder of polyethylene and polypropylene. With its pipe division (Polieco), it is further one of Europe's leading manufacturers of high-density, polyethylene, corrugated pipe systems. Within its compounding division (MPB), the company uses sorting systems for quality control to inspect and sort pellets which will be mainly used for films for food packaging. For this, Industrie Polieco-MPB relies on SIKORA's inspection and sorting system PURITY SCANNER ADVANCED and thus ensures its customers the highest material quality.



Blow film line at Industrie Polieco-MPB

At Industrie Polieco-MPB, the PURITY SCANNER ADVANCED is used at the final step of the production process in order to inspect for impurities maleic-anhydride grafted functional polymers. These polymers are used as adhesives and or/coupling agents and must be absolutely pure as they are further processed to products which will come in contact with food and/or drinking water. Indeed, among other applications, the material is

used as tie-layer in multilayer film structures for food packaging or as tie-layer in multilayer pipes for hot and cold drinking water installations inside buildings.

The PURITY SCANNER ADVANCED reliably detects pellets with color deviations, like light yellow or light beige pellets instead of colorless pellets, as well as small black spots on the pellet surface. These may occur because of side-reactions during the production of grafted polymers, as well known in literature. The PURITY SCANNER ADVANCED automatically sorts out all detected contamination starting at a size of 50 µm. Furthermore, the system provides various statistics as well as an image gallery of the detected contamination which helps Industrie Polieco-MPB to monitor and further improve its production process. "During the development and continuous improvement of our production processes, we have been able to minimize the formation of black spots and of pellets with color deviations. However, the presence of such defects cannot be completely avoided: sorting systems

like SIKORA's PURITY SCANNER ADVANCED have the essential task to get rid of such residual defects so that we can provide our clients a superior quality material", says Marina Ausonio, Research & Development Executive at Industrie Polieco-MPB.

→ SIKORA AG
Bruchweide 228307 Bremen,
Germany
www.sikora.net

The PURITY SCANNER ADVANCED detects pellets for impurities before they are further processed into films for food packaging



Post-consumer HDPE and PP Recycling Line for Turkish Plastics Recycler

Featuring Starlinger's special high-vacuum degassing unit, the recoSTAR dynamic 215 C-VAC has a production capacity of two tonnes of high-quality plastic pellets per hour and processes post-consumer HDPE and PP bottle flakes. The line is equipped with a SMART feeder which ensures ideal material preparation prior to extrusion, effectively drying and homogenising the input material.

"The Starlinger recoSTAR dynamic recycling lines have been designed with the focus on processing contaminated and highly humid post-consumer plastic waste", explained Paul Niedl, Commercial Head of Starlinger recycling technology. "The elaborate construction of the SMART feeder allows the recycling of materials with higher levels of humidity. In combination with Starlinger's Dynamic Automation Package which regulates the ideal operating point, it achieves a significant output increase."

The specially developed C-VAC degassing unit with its modern cascade setup takes care of volatile contaminants after the main extruder, effectively removing them by expanding the melt surface by 300 %.

Tanrikulu supplies the produced regranulate to the Turkish plastic product manufacturing industry. While the recycled polypropylene is used mainly to produce automobile plastic parts, furniture, toys and other injection moulding products, as well as for pallets, buckets or packaging films, the recycled polyethylene is used for pipes, bottles, plastic bags, and similar products.

"At Tanrikulu, we try to improve ourselves at every opportunity we get. For that, we continuously upgrade our production equipment", said İzzet Tanrikulu, General Manager of Tanrikulu Group of Companies. "To ensure best regranulate quality, the post-consumer input material passes metal detectors and filtration systems before being washed and sorted. The excellent vacuum degassing capacity of the Starlinger line combined with its high

Tanrikulu processes washed PP and PE flakes. The produced regranulate is used for automobile plastic parts, toys and other injection moulded products, as well as for bottles, buckets and packaging films, among others.



The Starlinger C-VAC degassing module increases the melt surface by 300 %, thus achieving an extremely high degassing efficiency (Pictures ©Starlinger)

production output helps us to achieve best product quality at favourable costs, ensuring continuous supply of high-quality PP and PE regranulate to our customers."

From paper, glass and metals to plastics recycling

With currently ten plastics recycling and manufacturing plants in various parts of Kocaeli Province, which borders the Istanbul metropolitan area, Tanrikulu originally started out in 1989 in Istanbul, recycling paper, glass and metal waste. In 2006 the company began to produce regranulate from plastic waste and diversified by adding a facility for the production of PET sheet in 2014. Since then, Tanrikulu has become one of the leading plastics recycling enterprises in Turkey and exports 50 % of its PET sheet products to overseas markets. Its plastics recycling capacity doubled after opening the Iz-pack PET packaging production facility in 2018 and installing automatic plastic sorting systems in 2019.

➤ Starlinger recycling technology
Furtherstrasse 47a, 2564 Weissenbach, Austria
www.recycling.starlinger.com

Tanrikulu
<http://tanrikulu.com.tr/en/>



Web conference

March 23, 2023 • Start: 10.00 CET

lab.extrusion-info.com

The official language
of the conference is English

Laboratory & quality control in plastics processing

Developed by:

VM VERLAG
Cologne/Germany

EXTRUSION

smart.molding
international

Our sponsors*:



* - at Lab & QC 2021

- Laboratory equipment
- Quality control of input raw materials
- Quality control of finished products
- Analytical equipment
- Measuring equipment
- Pilot and test lines
- Desktop mini IMM and mini extruders
- Laboratory mixers and compounders
- Laboratory and processing simulation software
- Metrology and equipment verification
- Laboratory analysis services
- Formulation development services
- Certification services
- External engineering and research services
- R&D in the enterprise



Chinaplas

国际橡塑展

A Brighter and Shared Future, Powered by Innovation.



Shenzhen World
Exhibition & Convention Center

2023

4·17
/
4·20



☎ Hong Kong (852) 2811 8897 | Singapore (65) 6631 8955 | 📞 (852) 6217 0885

✉ Chinaplas.PR@adsale.com.hk | 🌐 www.adsale.com.hk

📱  CHINAPLAS 🔍 www.ChinaplasOnline.com



Pre-Register Now!

Organizer



ADSALE 雅式 

Co-organizer



Sponsor



Official Online Media

